

Beschreibung	Referenz	Bestellnummer	Preis €
--------------	----------	---------------	---------



Lichtmaschine

2130974
1113090901

BOSCH Tausch 12V 11A

N393209
Kaution

passend für:

T80	WD113	1949-1964
T84	WD113	1956
T86	WD113A	1964-1968
T180	WD213	1953
T180a	WD213A	1953
T182	WD213C	1956-1959
T185	WD313	1955
T188	WD209	1960-1965
T190	WD306A	1964
T192		



Lichtmaschine

BOSCH Tausch 12V 16A

N395035
Kaution

passend für:

T185	WD113	1949-1964
T280	WD113	1956
T288	WD113A	1964-1968
T290	WD213	1953
	WD213A	1953
	WD213C	1956-1959
	WD313	1955
	WD209	1960-1965
	WD306A	1964



Riemenscheibe geteilt
für Gleichstromlichtmaschine
17mm Keilriemen

210 310 001

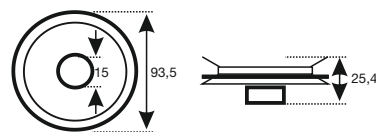

Gleichstromregler 14 Volt
OE BOSCH

11 Ampere
16 Ampere

306 A09 1500

210 200 028
210 200 046



Gleichstromanker 11 Ampere
Gleichstromanker 16 Ampere







1 104 012 071
1 104 013 427

210 320 071
210 320 427

Kohlensatz 11 Ampere
06x14x19 Länge
Kohlensatz 16 Ampere
06x22x25 Länge

1 107 014 144
1 107 014 140





GEBX169
GEBX165







	Beschreibung	Referenz	Bestellnummer	Preis €
	Wicklungssatz 11 Ampere	1 104 102 040/41	210 322 040	
	Kugellager 15 x 35 x 11 mm Kugellager 17 x 40 x 11 mm	6202 RS 6203 RS	210 323 202 210 323 203	
	Gummipfeife für Anschlüsse		ME006038.00	
	Keilriemen passend für:			
	T80, T84, T86, T180a, T182 T188 T190, T288, T290	17 x 1180 mm 9,5 x 1275 mm 9,5 x 1200 mm	097 171 180 097 101 275 097 101 200	
	Starter LETRIKA (Iskra) 12 V 2,7 KW 9 Z UMLAUFF 12 V 2,7 KW 9 Z	308 0009 906 0 001 354 088 0 001 362 036	IS0548 AIS0548	
	BOSCH Tausch 12 V 2,7 KW 9 Z passend für: T80 WD113 1949 T84 WD113A 1956 T86 WD113A 1964-1968 T188 WD209 1960-1965 T190 WD306A 1964	i Auf Anfrage auch mit 9 Volt-Anker lieferbar – für 1/3 mehr Drehmoment!	990644 Kaution	
	Starter LETRIKA (Iskra) 12 V 2,7 KW 9 Z UMLAUFF 12 V 2,7 KW 9 Z	0 001 354 091 0 001 362 076	IS0432 AIS0432	
	BOSCH Tausch 12 V 2,7 KW 9 Z passend für: T180 WD213 1953 T180A WD213A 1956-1959 T185 WD313 1955 T182	i Auf Anfrage auch mit 9 Volt-Anker lieferbar – für 1/3 mehr Drehmoment!	990971 Kaution	

	Beschreibung	Referenz	Bestellnummer	Preis €
	Starter	408 0009 906 0 001 358 020		
	LETRIKA (Iskra) 12V 3,0 KW 11 Z UMLAUFF 12V 3,0 KW 11 Z		IS0201 N291201	
	BOSCH Tausch 12V 3,0 KW 11 Z passend für: T288 WD406 1962 T290 WD406A 1966		990253 Kaution	
			<div style="border: 1px solid gray; padding: 5px; display: inline-block;"> i Auf Anfrage auch mit 9 Volt-Anker lieferbar – für 1/3 mehr Drehmoment! </div>	
	Starter	413 T090 001		
	Monark Neu 12V 3,5 KW 9 Z FKB BOSCH Tausch 12V 3,5 KW 9 Z FKB		081 468 012 990165 Kaution	
	passend für: T280 WD413 1952-1957			
	Anker 9 V 1,8 PS grobe Verzahnung	2 004 004 044	220 320 044	
	Anker 9 V 1,8 PS feine Verzahnung	2 004 004 051	220 320 051	
	Anker 9 V 3,0 PS grobe Verzahnung	2 004 004 081	220 320 081	
	Anker 9 V 3,0 PS feine Verzahnung	2 004 004 083	220 320 083	
	Ritzel 1,8 PS grobe Verzahnung	2 006 209 900	ZN 101 028	
	Ritzel 1,8 PS feine Verzahnung	2 006 209 086	ZN 101 318	
	Ritzel 3,0 PS grobe Verzahnung	2 006 209 917	ZN 101 226	
	Ritzel 3,0 PS feine Verzahnung	2 006 209 342	ZN 101 316	
	Kohlensatz 1,8 PS 09 x 13 x 25,5 mm Länge	1 007 014 100	GE BSX12	
	Kohlenfeder 1,8 PS	2 004 652 032	2 004 652 032	
	Kohlensatz 3,0 PS 08 x 22 x 22,5 mm Länge	2 007 014 006	GE BSX44	
	Kohlenfeder 3,0 PS	2 004 652 001	220 329 001	
	Lagerbuchsen			
	SIEMENS Vorne (mit Bund)	12,5 x 16,0 x 20,0mm	220 301 230	
	SIEMENS Mitte	19,0 x 22,5 x 11,0mm	220 301 231	
	SIEMENS Hinten	13,8 x 18,0 x 17,0mm	220 301 232	
	BOSCH Vorne	2 000 301 000	220 301 000	
	BOSCH Mitte	2 000 301 002	220 301 002	
	BOSCH Hinten	2 000 301 009	220 301 009	

	Beschreibung	Referenz	Bestellnummer	Preis €
	Reparatursatz Starter 12 V 1,8 PS Kohlensatz, Lagerbuchsen, Sprengring, Anschlagring und weitere Kleinteile		087 065 900	
	Magnetschalter 1,8 PS Magnetschalter 1,8 PS mit schrägen Anschlüssen Magnetschalter 3,0 PS	0 331 401 008 0 331 400 008 0 331 400 068 0 331 401 007	220 330 008 220 330 108 220 330 007	
	Magnetschalterkappe 1,8 PS Kontaktbrücke 1,8 PS		220 339 221 220 339 211	
	Gummipeife für elektrischen Anschluß	213 009 0030	N2803-1	
	Drehstartschalter OE BOSCH Drehstartschalter passend für: T80, T84, T86, T180, T180a, u.a. ► Gummikappe Drehstartschalter Innen Ø 11 mm ► Gummikappe Drehstartschalter Innen Ø 6 mm	0 343 401 001 180 058 0113 180 058 0113	0 343 401 001 K9 350 889 113 350 889 114	
	Zugstartschalter Mit 4 Steckanschlüssen Mit 4 Steckanschlüssen (Bosch) ► Zugknopf (Bosch) passend für: T188, T190, T288, T290	0 343 008 009 0 343 008 009 3 343 231 070	350 883 009 0 343 008 009 3 343 231 070	

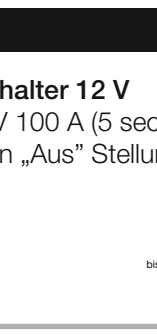
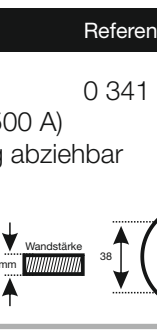
	Beschreibung	Referenz	Bestellnummer	Preis €
	Zugstartschalter			
	Mit 4 Schraubanschlüssen Mit 4 Schraubanschlüssen BOSCH	192 580 008 0 343 008 006	N2684 0 343 008 006	
	▶ Zugknopf	3 343 231 070	3 343 231 070	
	passend für: T188, T190, T288, T290			
<hr/>				
	Zündlichtschalter			
	Mit Steckanschlüssen BOSCH	0 342 201 010	N603 910	
	Mit Schraubanschlüssen Mit Schraubanschlüssen BOSCH	0 342 201 009 0 342 201 009	350 883 909 N603 009	
	passend für: T80, T84, T86, T180, T180a, u.a.			
	▶ Zündschlüssel	3 341 982 101	350 889 101	
<hr/>				
	Zündschlüssel rund alte Ausführung		350 889 305	
<hr/>				
	Blinkerschalter	0 341 300 002	083 862 810	
	1 Kreis Blinksystem, Einbau-Ø: 26 mm, Kontrolleuchte grün Anschlüsse: L/R/49a Schraubanschlüsse			
<hr/>				
	Blinkerschalter		350 884 007	
	2 Kreis Blinksystem Einbau-Ø: 26 mm, Kontrolleuchte rot Anschlüsse: 49a/49a/R/R/L/L/K Schraubanschlüsse			
	▶ Anzeigelampe		091 712 018	
<hr/>				
	Blinkerschalter	0 341 301 001	350 884 001	
	2 Kreis Blinksystem, Kontrolleuchte rot Einbau-Ø: 26 mm Anschlüsse: 49a/R/L/54R/54F/54/L/C/C Steckanschlüsse			
	▶ Anzeigelampe		091 712 018	

	Beschreibung	Referenz	Bestellnummer	Preis €
	<p>Lenkstockschalter Blinker Anschlüsse: L/R/54/K Befestigung: mit Spannband für Lenksäule Ø 38 - 41 mm</p> <p>passend für: Universal</p>		350 884 011	
	<p>Bremslichtschalter Zug ein</p> <p>passend für: universal</p>		350 871 008	
	<p>Bremslichtschalter Zug ein, mit Halteplatte</p> <p>passend für: T80, T84, T86, T180</p>		350 871 010	
	<p>Fußabblendschalter</p> <p>passend für: universal</p>		350 872 001	
	<p>Drucktaster M14 Belastbarkeit: 12 V / 1,4 A, 24 V / 0,7 A Wandstärke: bis 4 mm</p> <p>passend für: universal</p>		350 872 003	
	<p>Drucktaster M22 Belastbarkeit: 12V/24V max 150 Watt Wandstärke: bis 8 mm</p> <p>Flachstecker Schraubklemmen</p>		083 863 004 350 872 006	
	<p>Drucktaster metall Belastbarkeit: 24 V 400 W (1 sec) 24 V 250 W (2 min) Wandstärke: bis 8 mm mit Gummikappe als Feuchtigkeitsschutz</p>	<p>i Zum Starten geeignet!</p>	083 863 032	

Beschreibung	Referenz	Bestellnummer	Preis €
 <p>Batterietrennschalter 12 V Schaltstrom 12 V 100 A (5 sec 500 A) Schalt Schlüssel in „Aus“ Stellung abziehbar</p> <p>► Schalthebel</p>	0 341 001 001	350 882 001	
 <p>Batterietrennschalter 12/24 V Schaltstrom 12 / 24 V 100 A (5sec 500A) Schalt Schlüssel in „Aus“ Stellung abziehbar</p> <p>► Schalthebel</p>	6EK 002 843-001/2	350 882 987	
 <p>Batterietrennschalter 12/24 V Schaltstrom 12/24 V 250 A (5 sec 2500 A) Schalt Schlüssel in „Aus“ Stellung abziehbar</p> <p>► Schalthebel</p>	0 341 002 003	350 882 003	
 <p>Blinkgeber Bosch mechanisch</p> <p>12 V 2+1+1/18 W</p> <p>12 V 2+1+1/21 W</p>	0 336 202 001 0 336 200 038	N436 001	
 <p>Glühdrahtkerze</p> <p>passend für: T180, T80, T84, T86,</p>	213 0928 1213a090028	290 090 294	
 <p>Anschlussisolator für N404 294</p> <p>passend für: T180, T80, T84, T86</p>	213 0926 1213a090028	290 095 926	
 <p>Glühstiftkerze</p> <p>passend für: T190, T288, T290 teilweise 188</p>		290 090 198	

Beschreibung	Referenz	Bestellnummer	Preis €
 <p>Anschlussisolator für 290 090 198</p> <p>passend für: T190, T288, T290 teilweise 188</p>		290 095 927	
 <p>Flammglühkerze 1/2"</p> <p>passend für: teilweise 188</p>		1854040	
 <p>Vorglühspiralen</p> <p>1 Zylinder passend für: T80, T84, T86, T180, T185, T280 2 Zylinder passend für: T188 3 Zylinder passend für: T190 4 Zylinder passend für: T288, T290</p>		N845 832 N188 58 66 N190 58 10 N288 58 39	
 <p>Glühwiderstand komplett</p> <p>passend für: T80, T84, T86, T180, T185, T280</p>	84 5828	290 091 828	
 <p>Glühwiderstand vorne</p> <p>passend für: T80, T84, T86</p>	80 5850 1139 0903	290 091 850	
 <p>Glühwiderstand vorne</p> <p>passend für: T180</p>	180 5835	290 091 835	
 <p>Glühüberwacher</p> <p>passend für: universal</p>	0 251 002 001 KOS 08/50	290 092 850	

Beschreibung

Referenz

Bestellnummer

Preis €

Dieselszünder



Zündfix Ø 5 mm
Zündfix Ø 6 mm
Zündfix Ø 7 mm
Zündfix Ø 8 mm

HB29 000 105
HB29 000 106
HB29 000 107
HB29 000 108

Einschraubadapter für Zündfix

213 0445

351 990 002



passend für:
T80 (alte Serie)

Fernthermometer

80 58 0038

N2667-9



Ø 60mm
Fühler M10, Kabel ca 2000 mm

passend für:
T80, T84, T180, T188, T190, T288,
T290

Gummidichtung

180 5884
288 58 00 72
1288 58 00 72

N2666-8



für:
Öldruckmanometer N2666-9
Fernthermometer N2667-9

Metallabdeckung

verzinkt

N2666-7



für:
Öldruckmanometer N2666-9
Fernthermometer N2667-9

Einschraubadapter

N2666-6



für Fernthermometer N2667-9
Außen Ø: 14x1,5 mm
Innen Ø: 10x1,0 mm





Distanzring

N3430



für Fernthermometer N2667-9
von Ø 52 mm auf Ø 60 mm

	Beschreibung	Referenz	Bestellnummer	Preis €
	<p>Öldruckmanometer Ø 60 mm</p> <p>passend für: T80, T84, T180 u.a.</p>	80 5840	N2666-9	
	<p>Anschlussleitung gerade für Öldruckmanometer</p> <p>passend für: T80, T84, T86</p>	380 95 881 1380 95 881	300 100 105	
	<p>Anschlussleitung gekröpft für Öldruckmanometer</p> <p>passend für: T188</p>	380 95 8114 1380 95 8114	300 100 106	
	<p>Traktormeter Ø 80 mm</p> <p>passend für: teilweise T188, T190, T288, T290</p>	337 0058 00667	N2675	
	<p>Dichtgummi Ø 80 mm</p> <p>für Traktormeter N2675-8</p>	288 58 00701	N2675-8	
	<p>Traktormeterwelle Länge 1700 mm</p> <p>für Traktormeter N2675-8</p>	190 58 0061	N2679	
	<p>Winkeltrieb</p> <p>passend für: teilweise T188, T190, T288, T290</p>	92 58 0016	N2680	

Beschreibung	Referenz	Bestellnummer	Preis €
 <p>Kuppler</p> <p>passend für: teilweise T188, T190, T288, T290</p>	192 00 5836	N2681	
 <p>Sicherungsdose schwarz mit Schraubanschlüssen</p> <p>2-polig 4-polig 6-polig 8-polig 10-polig 12-polig</p>		HB50 300 211 N50411 HB50 300 610 HB50 300 810 N50414 HB50 300 120	
 <p>Kabelstrang komplett</p> <p>passend für: T80, T84</p>	192 00 5836	343 900 836	
 <p>Kabelbaum</p> <p>passend für: T180</p>		343 900 001	
 <p>Kabelbaum</p> <p>passend für: T180a</p>		343 900 002	

Oldies Beleuchtung

	Beschreibung	Referenz	Bestellnummer	Preis €
	Scheinwerfer Abmessung: Außen Ø 105 mm Befestigung: gerade M12 Schraube Metallgehäuse		100 400 843	
	(E) passend für: T80, T84			
	▶ Reflektor mit Streuscheibe verklebt		100 450 013	
	▶ Klammer für Scheinwerfereinsatz		100 550 003	
	▶ Scheinwerferlampe 12V 35/35 W Ba20d ▶ Kugellampe 12V 4 W Ba9s		091 612 093 091 712 016	
	Halterung passend für: T80	81 7238	100 550 238	
	Lagerblock passend für: T80	81 7250	100 550 250	
	Konsole rechts passend für: T80	81 7237	100 550 237	
	Scheinwerfer rechts Metallgehäuse passend für: T84		100 400 041	
	Scheinwerfer links Metallgehäuse passend für: T84		100 400 040	
	(E)			
	▶ Reflektor mit Streuscheibe verklebt		100 450 013	
	▶ Scheinwerferlampe 12V 35/35 W Ba20d ▶ Kugellampe 12V 4 W Ba9s		091 612 093 091 712 016	
	▶ Metallschelle		100 550 021	

Oldies Beleuchtung

	Beschreibung	Referenz	Bestellnummer	Preis €
	Reflektor Abmessung: Außen Ø 105 mm	W105	100 450 008	
	▶ Fassung ▶ Fassung Begrenzungslicht		100 550 004 100 550 016	
	<hr/>			
	Scheinwerferglas Abmessung: Außen Ø 105 mm	W105	100 450 010	
	▶ Dichtung		100 550 006	
<hr/>				
	Klammer für Scheinwerfereinsatz		100 550 003	
<hr/>				
	Scheinwerfereinsatz Abmessung: Außen Ø 105 mm passend für: universal		100 400 053	
<hr/>				
	Scheinwerfer Abmessung: Außen Ø 130mm Befestigung: gerade M12 Schraube Metallgehäuse		100 400 042	
	passend für : universal			
	▶ Reflektor mit Streuscheibe verklebt ▶ Scheinwerferlampe 12 V 45/40 W Ba20d ▶ Kugellampe 12 V 4 W Ba9s		100 450 013 LK 14732 091 712 016	
<hr/>				
	Scheinwerfer Abmessung: Außen Ø 130 mm Befestigung: Schraube M18 (Ei-Förmig) Metallgehäuse Kabelausgang durch Schraube		100 400 044	
	passend für: universal			
	▶ Scheinwerferlampe 12 V 35/35 W P45t ▶ Kugellampe 12 V 4 W Ba9s		091 512 006 091 712 016	

Oldies Beleuchtung

	Beschreibung	Referenz	Bestellnummer	Preis €
	<p>Scheinwerfer Abmessung: Außen Ø 130 mm M24 Befestigung: Rohranschluss gerade Metallgehäuse</p> <p>passend für: T180 u.a.</p>		100 400 046	
				
	<ul style="list-style-type: none"> ▶ Fassung ▶ Scheinwerferlampe 12 V 35/35 W Ba20d ▶ Adapter 		100 550 015 091 612 093 100 550 017	
	<p>Scheinwerfereinsatz für 100 400 046 mit schwarzen Ring</p>		100 450 011	
	<p>Scheinwerfereinsatz für 100 400 046 mit Chrom Ring</p>		100 450 012	
	<p>Scheinwerfer Ei-Form Abmessung: Außen Ø 130 mm Befestigung: Rohranschluss gerade Metallgehäuse</p> <p>passend für: T180</p>		100 400 180	
	<ul style="list-style-type: none"> ▶ Scheinwerfergehäuse (Rohling) Für Originalscheinwerfer T180 		100 550 020	
	<ul style="list-style-type: none"> ▶ Scheinwerferlampe 12 V 45/40 W P45t ▶ Standlichtlampe 12 V 4 W Ba9s ▶ Adapter 		091 512 006 091 712 016 100 550 017	







Oldies Beleuchtung







	Beschreibung	Referenz	Bestellnummer	Preis €
	<p>Scheinwerfer links Abmessung: Außen Ø 130 mm Befestigung: Rohranschluss Metallgehäuse</p> <p>passend für: T188, T190, T288, T290</p>		100 400 048	
	<p>Scheinwerfer rechts Abmessung: Außen Ø 130 mm Befestigung: Rohranschluss Metallgehäuse</p> <p>passend für: T188, T190, T288, T290</p>		100 400 049	
	<ul style="list-style-type: none"> ▶ Fassung ▶ Scheinwerferlampe 12 V 35/35 W Ba20d ▶ Adapter 		100 550 015 091 612 093	
	<p>Scheinwerfereinsatz für 100 400 048/049 mit schwarzem Ring</p>		100 450 011	
	<p>Scheinwerfereinsatz für 100 400 048/049 mit Chrom Ring</p>		100 450 012	
	<p>Reflektor Abmessung: Außen Ø 130 mm</p> <ul style="list-style-type: none"> ▶ Fassung 	W130	100 450 009	
	<p>Scheinwerferglas Abmessung: Außen Ø 130 mm</p> <ul style="list-style-type: none"> ▶ Dichtung 	W130	100 450 015	100 550 002

Oldies Beleuchtung

	Beschreibung	Referenz	Bestellnummer	Preis €
	<p>Positionsleuchte Abmessung: 115 x 60 x 42 mm Befestigung: 2 Löcher für M4 Schrauben Lochabstand: 70 mm</p> <p>passend für: universal</p> <p>▶ Lichtscheibe ▶ Kugellampe 12 V 5 W Ba15s</p>		100 204 002	
	<p>Positionsleuchte Abmessung: Ø 70 x 36 mm Befestigung: 2 Löcher M4 f Lochabstand: 33 mm mit Chromring</p> <p>passend für: universal</p> <p>▶ Soffittenlampe 12 V 5 W 36 mm</p>		100 204 003	
	<p>Blink-, Positionsleuchte</p> <p>passend für: teilweise Jubiläumsserie/universal</p> <p>▶ Lichtscheibe ▶ Kugellampe 12 V 21/5 W BAY15d ▶ Soffittenlampe 12 V 21 W S8,5</p>		100 204 010	
	<p>Lichtscheibe gelb/weiß</p> <p>passend für: T188/190/288/290</p>	<p>i Für Original-Leuchten!</p>	100 254 007	
	<p>Blinkleuchte Abmessung: 83 x 40 x 41 mm Befestigung: 2 Schrauben M4 Lochabstand: 28 mm</p> <p>passend für: universal</p> <p>mit Chromring mit schwarzem Ring</p> <p>▶ Soffittenlampe 12 V 18 W</p>		100 206 020 100 206 021	091 812 031

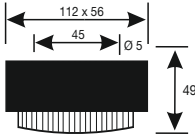
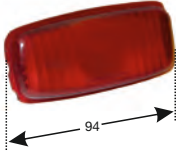
Oldies Beleuchtung

	Beschreibung	Referenz	Bestellnummer	Preis €
	<p>Blinkleuchte Abmessung: Ø 65 x36 mm Befestigung: 2 Schrauben M4 Lochabstand: 23 mm</p> <p>passend für: universal</p> <p>▶ Soffittenlampe 12 V 18 W</p>		<p>100 206 022</p> <p>091 812 031</p>	
	<p>Lichtscheibe für Blinker</p> <p>passend für: T86</p>	<p>i Für Original-Leuchten!</p>	<p>100 256 002</p>	
	<p>Schlussleuchte Abmessung: 115 x 60 x 42 mm Befestigung: 2 Löcher für M4 Schrauben Lochabstand: 70 mm</p> <p>passend für: universal</p> <p>▶ Lichtscheibe ▶ Kugellampe 12V 5W Ba15s</p>		<p>100 104 012</p> <p>100 154 012 091 612 012</p>	
	<p>Schlussleuchte Abmessung: Ø 70 x 36 mm Befestigung: 2 Löcher für M4 Schrauben Lochabstand: 33 mm mit Chromring</p> <p>passend für: universal</p> <p>▶ Soffittenlampe 12 V 5 W 36 mm Soffittenlampe 24 V 5 W 36 mm</p>		<p>100 104 014</p> <p>091 812 026</p>	
	<p>Schlussleuchte Abmessung: Ø 65 x 54 mm Befestigung: M5 Schraube Metallgehäuse</p> <p>passend für: universal</p> <p>▶ Soffittenlampe 12 V 5 W 36 mm</p>		<p>100 104 013</p> <p>091 812 026</p>	
	<p>Gummiunterlage 3 Loch Abmessung: 62 x 42 mm</p> <p>für 100 104 013</p>		<p>100 550 019</p>	<p>10,00</p>

Beschreibung	Referenz	Bestellnummer	Preis €
	Schluss-, Bremsleuchte Abmessung: 84 x 84 x 81 mm Befestigung: 2 Löcher für M4 Schrauben Lochabstand: 45 mm		
	passend für: universal		
	ohne Kennzeichenbeleuchtung mit Kennzeichenbeleuchtung	100 104 010 100 104 011	
	► Kugellampe 12 V 21 W Ba15s ► Soffittenlampe 12 V 5 W 36 mm	091 612 010 091 812 026	
	Schluss-, Bremsleuchte mit Kennzeichenleuchte ohne Kennzeichenleuchte		
	passend für: teilweise T80, T84, T86, T188, T190, T288, T290		100 104 015 100 104 016
	► Lichtscheibe ► Soffittenlampe 12 V 21 W 41 mm ► Soffittenlampe 12 V 5 W 41 mm	100 154 013 091 812 035 091 812 066	
	Lichtscheibe für Originalleuchte		100 154 001
	Lichtscheibe Alternative		100 154 013
	passend für: Steyr		
	Schluss-, Bremsleuchte mit Kennzeichenbeleuchtung 2 Funktionen Ø 90 x 65 mm Metall Befestigung 2 x 6 Kantschraube Lochabstand: 45mm		100 104 017
	passend für: universal		
	► Lichtscheibe Rot/Rot ► Kugellampe 12 V 21 W Ba15s ► Soffittenlampe 12V 5 W S8,5 41 mm	100 150 094 091 612 010 091 812 066	
	Gummiunterlage 4 Loch Abmessung: 65 x 55 mm		100 550 005
	für: 100 107 014, 100 100 078/079I		

Oldies Beleuchtung

Beschreibung

Referenz

Bestellnummer

Preis €

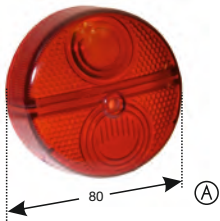

Lichtscheibe
rot/rot
ohne Kennzeichenleuchte

passend für:
T80/T84/T86

i Für Original-Leuchten!

100 154 002

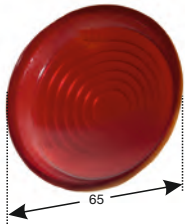

Lichtscheibe
rot

passend für:
Steyr

i Für Original-Leuchten!

100 154 005



Schluss-/Brems-, Blinkleuchte

2 Funktionen
Ø 90 x 65 mm Metall
Befestigung: 2 x 6 Kantschraube
Lochabstand 45 mm

passend für:
universal



ohne Kennzeichenbeleuchtung
mit Kennzeichenbeleuchtung

- ▶ Lichtscheibe Gelb / Rot
- ▶ Kugellampe 12 V 21 W Ba15s
- ▶ Soffittenlampe 12 V 5 W S8,5 41 mm

100 100 079

100 100 078

100 150 095

091 612 010

091 812 026



Gummiunterlage 4 Loch

Abmessung: 65 x 55 mm

für: 100 100 078/079

100 550 005



Schluss-, (Brems-), Blinkleuchte

2 Funktionen
Abmessung: Ø 80 x 63 mm Metall
Befestigung: 2 x M6 Schraubenlöcher

passend für:
universal

ohne Kennzeichenbeleuchtung
mit Kennzeichenbeleuchtung

- ▶ Soffittenlampe 12 V 18 W S8,5 41 mm
- ▶ Soffittenlampe 12 V 5 W S8,5 41 mm

100 100 099

100 100 100







091 812 031

091 812 026

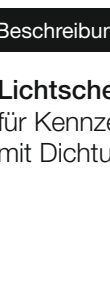

Oldies Beleuchtung

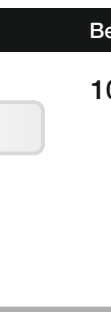



	Beschreibung	Referenz	Bestellnummer	Preis €
	<p>Schluss-, Brems-, Blinkleuchte 3 Funktionen Abmessung: Ø 80 x 43 mm, 2 Befestigungsschrauben, Schraubenabstand: 45 mm</p> <p>passend für: teilweise Jubiläumsserie, universal</p> <ul style="list-style-type: none"> ▶ Lichtscheibe ▶ Lichtscheibe mit Kennzeichenbeleuchtung 		<p>100 100 075</p> <p>100 150 075</p> <p>100 150 076</p> <p>091 612 008</p> <p>091 812 035</p>	
	<p>Schluss-, Brems-, Blinkleuchte Abmessung: Ø 115 x 55 mm, Schraubenabstand: 44 mm mit Kennzeichenbeleuchtung</p> <p>passend für: universal</p> <ul style="list-style-type: none"> ▶ Lichtscheibe ▶ Soffittenlampe 12 V 5 W S8,5 36 mm ▶ Soffittenlampe 12 V 18 W S8,5 41 mm 		<p>100 100 089</p> <p>100 150 088</p> <p>091 812 026</p> <p>091 812 031</p>	
	<p>Kennzeichenleuchte Abmessung: 82,7 x 30 x 34 mm Befestigung: 2 Schrauben M5 Schraubenabstand: 45 mm</p> <p>passend für: universal</p> <ul style="list-style-type: none"> ▶ Soffittenlampe 12 V 5 W SV8,4-8 		<p>100 106 010</p> <p>091 812 026</p>	
 <p>100 106 003</p>	<p>Kennzeichenleuchte Hella Abmessung: 82 x 26 x 31 mm Befestigung: 2 Schrauben M5 Schraubenabstand: 45 mm</p> <p>passend für: universal</p> <ul style="list-style-type: none"> ▶ Soffittenlampe 12 V 5 W SV8,4-8 		<p>100 106 003</p> <p>100 106 004</p> <p>100 106 005</p>	
 <p>100 106 005</p>	<p>Kunststoff-Gehäuse Metall-Gehäuse Chrom-Gehäuse</p>		<p>100 106 003</p> <p>100 106 004</p> <p>100 106 005</p>	



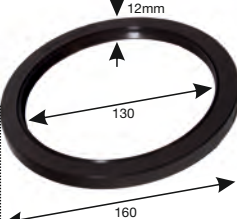
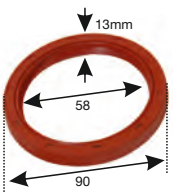
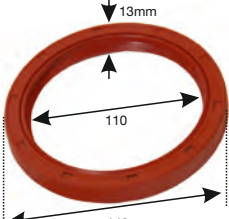

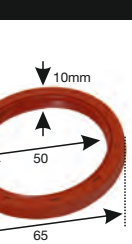
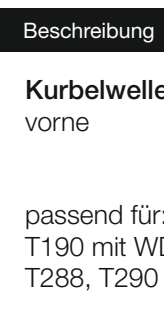

Oldies Beleuchtung

Beschreibung	Referenz	Bestellnummer	Preis €
 <p>Lichtscheibe für Kennzeichenleuchte mit Dichtung</p>	 Für Original-Leuchten!	100 156 001	
 <p>Kontrollleuchte Abmessung: Ø 24 x 41 mm Lochgröße: Ø 17,5 mm Wanddicke bis 4 mm Flachstecker</p> <p>passend für universal</p> <p>rot grün blau gelb</p>	 Zur besseren Erregung der Lichtmaschine die 2 Watt Lampen verwenden!	100 208 001 100 208 002 100 208 003 100 208 004	
<p>▶ Glassockellampe 12 V 2 W W2,0x4,6d</p>		091 712 700	
 <p>Kontrollleuchte Abmessung: Ø 24 x 45 mm Lochgröße: Ø 17,5 mm Schraubanschluss</p> <p>passend für: universal</p> <p>rot grün blau gelb</p>		100 208 005 100 208 006 100 208 007 100 208 008	
<p>▶ Kugellampe 12 V 2 W Ba9s</p>		091 712 028	
 <p>Kontrollleuchte Abmessung: Ø 22 x 45 mm Lochgröße: Ø 17,5 mm Schraubanschluss</p> <p>passend für: universal</p> <p>rot grün</p>		100 208 013 100 208 014	
<p>▶ Kugellampe 12 V 2 W Ba9s</p>		091 712 028	
 <p>Rückstrahler rot Alu Befestigung: M5 Schraube</p> <p>passend für: universal</p> <p>Außen Ø 50 mm Außen Ø 80 mm</p>		100 622 001 100 622 004	

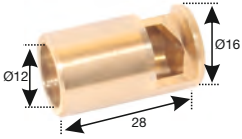
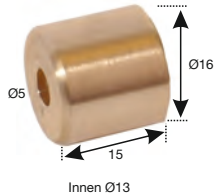
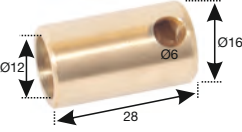
Oldies Motor

	Beschreibung	Referenz	Bestellnummer	Preis €
	<p>Kurbelwelle</p> <p>passend für: T190 mit WD306 Motor</p>	308 0002 0028	500 022 306	
	<p>Kurbelwelle</p> <p>passend für: T288, T290 mit WD406 Motor</p>	406 02 0012	500 022 406	
	<p>Kurbelwellensimmering vorne</p> <p>passend für: T180, T80</p>		500 122 005	
	<p>Kurbelwellensimmering hinten</p> <p>passend für: T180, T80</p>		500 122 006	
	<p>Kurbelwellensimmering vorne</p> <p>passend für: T188</p>		500 122 003	
	<p>Kurbelwellensimmering hinten</p> <p>passend für: T188</p>		500 122 004	

Beschreibung	Referenz	Bestellnummer	Preis €
 <p>Kurbelwellensimmering vorne</p> <p>passend für: T190 mit WD306 Motor T288, T290 mit WD406 Motor</p>		500 122 001	
 <p>Kurbelwellensimmering hinten</p> <p>passend für: T190 mit WD 306 Motor T288, T290 mit WD406 Motor</p>		500 122 002	
 <p>Anlaufscheiben-Satz für Kurbelwelle</p> <p>passend für: T188 WD209</p>		500 122 107	
<p>Anlaufscheiben-Satz für Kurbelwelle</p> <p>passend für: T190 WD306/307 T288/290 WD406/407</p>		500 122 108	
 <p>Zylinderkopf mit Ventilen</p> <p>neu instandgesetzt</p> <p>passend für: T80, T84, T86, T180/a</p>		500 020 901 500 020 900	
 <p>Zylinderkopfschraube</p> <p>kurz (150 mm) 213 0132 lang (175 mm) 213 0131</p> <p>passend für: T80, T84, T86, T180/a, T185/a</p> <p>i Je Zylinder-Kopf 2 Stk.!</p>		500 020 001 500 020 002	
<p>Mutter für Zylinderkopf</p> <p>passend für: T80, T84, T86, T180/a, T185/a</p>	213 0154	500 020 004	

	Beschreibung	Referenz	Bestellnummer	Preis €
	Spezialbeilagscheibe für Zylinderkopf passend für: T80, T84, T86, T180/a, T185/a	213 0168	500 020 003	
	Wasserrohr bei Zylinderkopf (Kühlwasserübertritt) passend für: T80, T84, T86, T180 ab Motor Nr 9000 T180a, T182, T185, T280	4139 01169 14139 010169	500 211 002	
	Wasserrohr bei Zylinderkopf (Kühlwasseraustritt) passend für: T180 26PS bis Motor Nr 9000	12130 010038	500 211 004	
	Wasserrohr bei Zylinderkopf (Kühlwasseraustritt) passend für: T80, T84, T86, T180 ab Motor Nr 9000 T180a, T182, T185, T280	14136 010 153 1413C 010004	500 211 003	
	Kolben-Büchsenatz (Assy) Büchsen-, Kolben-, O-Ringe Bohrung Ø 110 mm		N0142-9	
	Kolben-Büchsenatz (Assy) Büchsen-, Kolben-, O-Ringe Bohrung Ø 115 mm für mehr Leistung	 Oldtimer Tuning – mehr Leistung!	500 321 001	
	passend für: T80, T84, T86, T180, T180/a, T280			
	Büchsenringe Rot Schwarz		N0041-1 N0041-2	
	passend für: T80, T84, T86, T180, T180/a, T280			
	Kolbenringsatz passend für: T80, T84, T86, T180, T180/a, T280		N0149-9	

Beschreibung

Referenz

Bestellnummer

Preis €



Symbolfoto

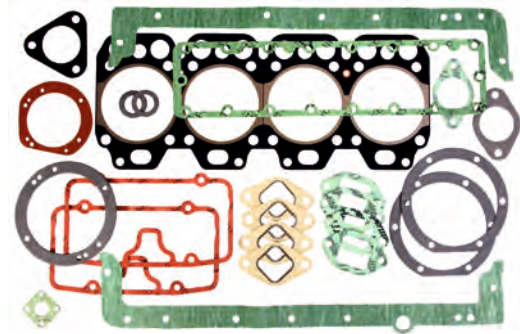

Symbolfoto



Symbolfoto



Symbolfoto

Motor Rep-Satz

1 Zylinder WD113

passend für:

T80, T84, T86

WD213 x 2 / WD313 x 3 / WD413 x 4

Set bestehend aus:

Kolben/Büchsen/Satz 1 x N0142-9

Pleuellagerpaar 1 x N0138-1

Kopfdichtsatz 1 x 503 019 802

Motor Rep-Satz

3 Zylinder WD306

passend für:

T190

Set bestehend aus:

Kolben/Büchsen/Satz 3 x N0142-KT95

Pleuellagersatz 1 x N0137

Entrußersatz 1 x 503 919 023

Kopfdichtung 1 x 500 121 002

Motor Rep-Satz

4 Zylinder WD406

passend für:

T288

Set bestehend aus:

Kolben/Büchsen/Satz 3 x N0142-KT85

Pleuellagersatz 1 x N0137

Entrußersatz 1 x 503 192 831

Kopfdichtung 1 x 500 121 003

Motor Rep-Satz

4 Zylinder WD406

passend für:

T290

Set bestehend aus:

Kolben/Büchsen/Satz 4 x N0142-KT95

Pleuellagersatz 1 x N0137

Entrußersatz 1 x 503 192 831

Kopfdichtung 1 x 500 121 004

Beschreibung	Referenz	Bestellnummer	Preis €
--------------	----------	---------------	---------



Kolben Lochbrenner
passend für:
T188 Motor WD209



Standard	Ø 105 mm	500 021 009
1. Rep.- Stufe	Ø 105,5 mm	500 021 010
2. Rep.- Stufe	Ø 106 mm	500 021 011

Kolben Maulbrenner
passend für:
T188 Motor WD209



Standard	Ø 105 mm	500 021 012
1. Rep.- Stufe	Ø 105,5 mm	500 021 013
2. Rep.- Stufe	Ø 106 mm	500 021 014

Kolbenringsatz
passend für:
T188 Motor WD209



Standard	Ø 105 mm	500 221 003
1. Rep.- Stufe	Ø 105,5 mm	500 221 006
2. Rep.- Stufe	Ø 106 mm	500 221 007

Kolben / Büchsen / Ring Satz
mit Büchsenringe
Bohrung Ø 98 mm

N0142-KT95



passend für:
T190/290

Büchsenring
Bohrung Ø 98 mm

N0041



passend für:
T190/290

Kolbenringsatz
Bohrung Ø 98 mm

500 221 004



passend für:
T190/290

Kolben / Büchsen / Ring Satz
Bohrung Ø 92 mm

N0142-KT85



passend für:
T288

Beschreibung	Referenz	Bestellnummer	Preis €
--------------	----------	---------------	---------



Büchsenring
Bohrung Ø 92 mm

N288

passend für:
T288



Kolbenringsatz
Bohrung Ø 92 mm

500 221 005

passend für:
T288



Pleuellagersatz

Standard
Übermaß 0,25 mm
Übermaß 0,50 mm

1 Paar
1 Paar
1 Paar

N0138-1
N0138-5
N0139-3

passend für:
T80, T84, T86, T180/a, T185, T280

Pleuellagersatz

Standard
Übermaß 0,25 mm

1 Paar
1 Paar

N0137-1
N0139-2

passend für:
T188



Pleuellagersatz

Standard
Übermaß 0,25 mm
Übermaß 0,50 mm
Übermaß 0,75 mm

1 Satz (4 Paar)
1 Satz (4 Paar)
1 Satz (4 Paar)
1 Satz (4 Paar)

N0137
N0138
N0139
N0140

passend für:
T190, T288, T290



Pleuelbuchse
Rohling

500 015 337

passend für:
T80, T84, T86, T180/a, T185, T280

i Buchse muss nach dem Einpressen gebohrt werden!

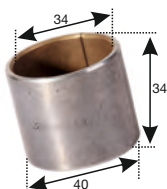





Pleuelbuchse

407 03 0011

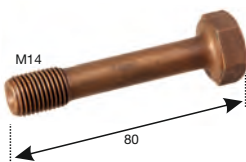
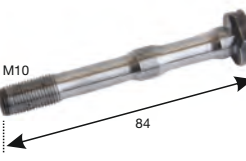

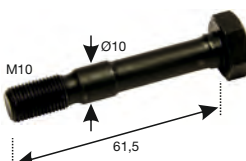
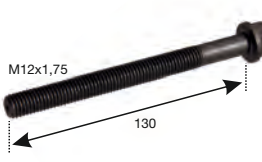

N0136

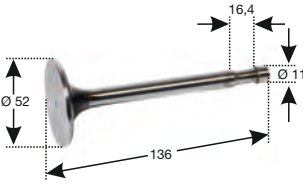
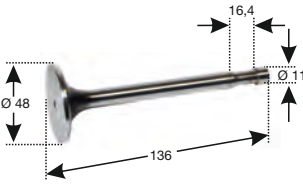
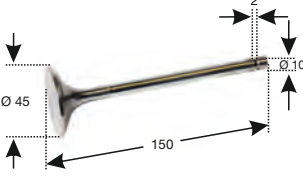
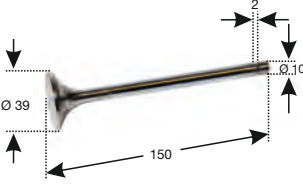
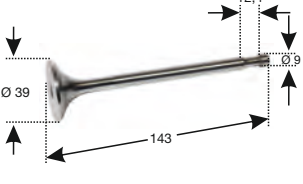
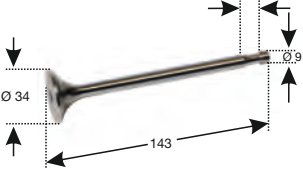
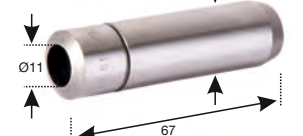



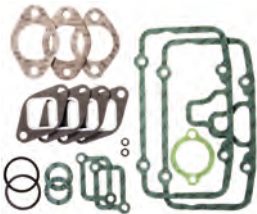

passend für:
T190, T288, T290







	Beschreibung	Referenz	Bestellnummer	Preis €
	Pleuelschraube passend für: T80, T84, T86, T180/a, T185, T280	213 0324	500 015 324	
	Pleuelschraube passend für: T188	609 0318	500 015 002	
	Pleuelschraubenmutter passend für: T188	609 0313	500 015 003	
	Pleuelschraube passend für: T190, T288, T290	406 U03 0002	N0141	
	Zylinderkopfschraube ersetzt die Stehbolzen passend für: T190, T288, T290	1408 00 00 4030	N0159-1	
	Hauptlager Paar Standard Übermaß 0,25 mm passend für: T188	i Je Motor werden 3 Paar benötigt!	500 016 003	
			500 016 203	
	Hauptlagersatz Standard Übermaß 0,25 mm Übermaß 0,50 mm Übermaß 0,75 mm Übermaß 1,00 mm passend für: T190, T288, T290	1 Satz (5 Paar)	N0017	
		1 Satz (5 Paar)	N0018	
		1 Satz (5 Paar)	N0019	
		1 Satz (5 Paar)	N0020	
		1 Satz (5 Paar)	N0021	





	Beschreibung	Referenz	Bestellnummer	Preis €
	Einlassventil passend für: T80, T84, T86, T180/a, T182, T185, T280	413C 050042	500 014 042	
	Auslassventil passend für: T80, T84, T86, T180/a, T182, T185, T280	2130 050039	500 014 039	
	Einlassventil passend für: T188	609 0512	500 014 001	
	Auslassventil passend für: T188	209 0515	500 014 002	
	Einlassventil passend für: 190/288/290	406 05 0006	500 014 106	
	Auslassventil passend für: 190/288/290	406 05 0007	500 014 107	
	Ventilführung passend für: T80, T84, T86, T180/a, T182, T185, T280	213 04 0072	500 114 472	

Beschreibung	Referenz	Bestellnummer	Preis €
 <p>Ventilführung lang für Einlassventil</p> <p>passend für: T188</p>		500 114 003	
 <p>Ventilführung kurz für Auslassventil</p> <p>passend für: T188</p>	2130 050039	500 114 004	
 <p>Ventilführung lang für Einlassventil</p> <p>passend für: T190, 288, 290</p>	311 0004 0029	500 114 005	
 <p>Ventilführung kurz für Auslassventil</p> <p>passend für: T190, 288, 290</p>	406 04 0603	500 114 006	
 <p>Ventilfeder</p> <p>passend für: T80, T84, T86, T180/a, T182, T185, T280</p>	413 90 539	500 099 003	
 <p>Stößel</p> <p>passend für: T188, T190, T288, T290</p>	609 05 0002	500 114 001	
 <p>Zahnkranz</p> <p>passend für: T190 T288, T290</p>	209 00 02 0034 610 00 02 0021	520 006 013 526 006 014	



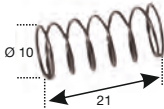
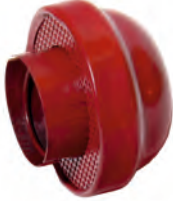

Beschreibung	Referenz	Bestellnummer	Preis €
 <p>Entrußersatz inkl Ventildeckeldichtung und Kopfdichtung 0,8mm</p> <p>Übermaß 1,0 mm Übermaß 1,2 mm</p> <p>passend für: T80, T84, T86, T180/a, T182, T185, T280</p>	113 01 0706	503 019 802	
		503 019 804	
		503 019 806	
 <p>Entrußersatz</p> <p>passend für: T188 T190 T288, T290</p>		503 019 867	
		503 919 023	
		503 192 831	
 <p>Zylinderkopfdichtung</p> <p>passend für: T188</p>	207 04 007	500 121 007	
 <p>Zylinderkopfdichtung Ø 98 mm Bohrung</p> <p>passend für: T190</p>		500 121 002	
 <p>Zylinderkopfdichtung Ø 92 mm Bohrung</p> <p>passend für: T288</p>	406 040 0112	500 121 003	
 <p>Zylinderkopfdichtung Ø 98 mm Bohrung</p> <p>passend für: T290</p>	406 U04 0024	500 121 004	





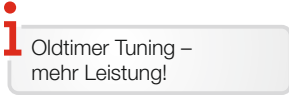

Beschreibung	Referenz	Bestellnummer	Preis €
Motordichtsatz			
 <p>passend für: T80, T84, T86 T180/a</p>		503 019 800	
		503 198 018	
T182		503 198 018	
Dichtung für seitlichen Deckel	zusätzlich	503 191 804	
T188		503 186 768	
T190		503 190 231	
T288, T290		503 928 310	
<hr/>			
 <p>Dichtung für unteren Deckel in 503 019 800 enthalten</p> <p>passend für: T80, T84, T86</p>	113 01 09	503 019 820	
<hr/>			
 <p>Dichtung für seitlichen Deckel rechts in 503 019 800 enthalten</p> <p>passend für: T80, T84, T86</p>	113 01 07	503 019 822	
<hr/>			
 <p>Dichtung für seitlichen Deckel links in 503 019 800 enthalten</p> <p>passend für: T80, T84, T86</p>	113 01 05	503 019 823	
<hr/>			
 <p>Dichtung für großen seitlichen Deckel</p> <p>passend für: T182</p>	113 01 05	503 191 804	
<hr/>			
 <p>Dichtung für Spaltölfilter in 503 019 800 und 018 enthalten</p> <p>passend für: T80, T84, T86, T180/a, T182</p>	270 17 12	503 019 827	







	Beschreibung	Referenz	Bestellnummer	Preis €
	Dichtring Vorkammer passend für: T80/T84/T86/T180/T185/T280	213 04 28	500 099 428	
	Ölwannendichtung passend für: T188		503 191 891	
	Ölwannendichtung passend für: T190		135 010 003	
	Ölwannendichtung passend für: T288, T290	406 15 0007	135 010 007	
	Ölablassschraube Inbus M38 x 1,5 passend für: universal, T80, T84, T86		520 006 915	
	Ölablassschraube ► Kupferscheibe 38 x 44 x 2 mm passend für: T80, T84, T86, T180		520 006 903	520 006 904
	Betätigungsstange für Dekompressor passend für: T80, T84	111 30 40046	500 099 046	

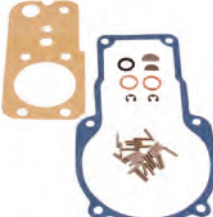





Beschreibung	Referenz	Bestellnummer	Preis €
Hebelplatte für Dekompressor		500 099 024	
	passend für: T80, T84		
Distanzrohr für Dekompressor	180 041 0007 180 041 0004	500 099 025	
	passend für: T80, T84		
Blattfeder für Dekompressorwelle	12130040010	523 100 012	
	passend für: T80, T84, T86, T180/a, T182, T185		
Druckfeder zu Druckbolzen bei Öleinfüllstutzen	12130080150	500 018 002	
	passend für: T80, T84, T86		
Motorentlüftungskappe mit Ventil	113 0119	500 018 080	
	passend für: T80		
Motorentlüftungskappe	270 21 41	500 018 180	
	passend für: T180		
Ölpumpe	406 A 07 0601	500 218 601	
	passend für: T190, T288, T290		

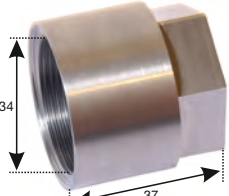

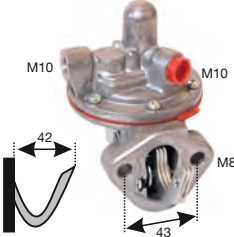



Oldies Dieselteile







Beschreibung	Referenz	Bestellnummer	Preis €
	Einspritzpumpe Tausch 1 Zylinder	135 460 001 Kaution	
	passend für: T80, T84, t86		
	Einspritzpumpen Paar Tausch 2 Zylinder ohne Kaltstartknopf	135 460 002 Kaution	
	passend für: T180 (26PS)		
	Einspritzpumpen Paar Tausch 2 Zylinder mit Kaltstartknopf	135 460 003 Kaution	
	passend für: T180		
	Pumpenelement	9 413 362 402	135 210 402
	Pumpenelement mehr Menge		135 210 404
	passend für: T80, T84, T86, T180		
	Pumpenelement		135 210 403
	passend für: T188		
	Pumpenelement		135 210 404
	passend für: T280		
	Pumpenelement		135 210 431
	passend für: T290		
	Druckventil	9 412 362 879	135 211 879
	passend für: T80, T84, T86, T180		

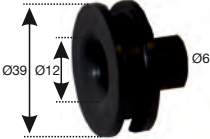

Beschreibung	Referenz	Bestellnummer	Preis €
 <p>Dichtscheibe Friedmann-Maier passend für: T80, T84, T86</p>	9 413 360 776	135 010 776	
 <p>Pumpenfeder Friedmann-Maier passend für: diverse Steyr Typen</p>	9 413 365 007	135 255 007	
 <p>Leerlauffeder Friedmann-Maier passend für: diverse Steyr Typen</p>	9 413 365 425	135 255 425	
 <p>Leerlauffeder Friedmann-Maier passend für: diverse Steyr Typen</p>	9 413 365 431	135 255 431	
 <p>Regelfeder Friedmann-Maier passend für: diverse Steyr Typen</p>	9 423 325 510	135 255 510	
 <p>Regelfeder Friedmann-Maier passend für: diverse Steyr Typen</p>	9 423 325 560	135 255 560	
 <p>Reglerdichtsatz Friedmann-Maier für R8 Regler passend für: diverse Steyr Typen</p>		135 254 238	

	Beschreibung	Referenz	Bestellnummer	Preis €
	<p>Rolle Friedmann-Maier</p> <p>passend für: diverse Steyr Typen</p>	9 903 362 121	135 252 121	
<hr/>				
<p>Einspritzpumpen -Dichtsätze Friedmann-Maier</p>				
 <p>Symbolbild 135 011 133</p>	<p>Pumpentyp P22 Steyr 188</p>		135 011 132	
	<p>Pumpentyp P23 Steyr 190</p>		135 011 133	
	<p>Pumpentyp P24 Steyr 288/290</p>		135 011 134	
<hr/>				
<p>Seitendeckel -Dichtungen Friedmann-Maier</p>				
	<p>Pumpentyp P22 Steyr 188</p>	9 413 360 207	135 010 207	
	<p>Pumpentyp P23 Steyr 190</p>	9 413 360 208	135 010 208	
	<p>Pumpentyp P24 Steyr 288/290</p>	9 413 360 209	135 010 209	
<hr/>				
	<p>Regelfeder für Einspritzpumpe</p> <p>passend für: T80</p>	<p>213 005 0081 1213 005 0081 1213 005 0081N</p>	135 250 001	
<hr/>				
	<p>Überwurfmutter für Regelgestänge mit Passung für Wellendichtring</p> <p>passend für: T80, T84, T86, T180 teilweise</p>	213F 05 0002	135 250 002	

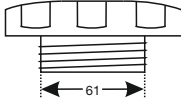
Beschreibung	Referenz	Bestellnummer	Preis €
 <p>Särke 7 mm 14 24</p>	<p>Wellendichtring für Überwurfmutter</p>	135 250 003	
<p>passend für: T80, T84, T86, T180 teilweise</p>			
 <p>M10 M10 M8 42 43</p>	<p>Membranförderpumpe</p>	213F0805	135 100 055
<p>passend für: T182, T180a teilweise</p>			
	<p>Förderpumpe V1 Friedmann & Maier mit Vorreiniger</p>	<p>9 440 361 305 9 440 361 306 9 440 361 356 9 440 361 359</p>	135 100 037
<p>passend für: T185, T280 u div. LKW</p>	<p>i Achtung: passt nur für die angeführten Typen!</p>		
	<p>Förderpumpe V2HF Friedmann & Maier Anschlüsse nach oben mit Schauglas</p>	<p>9 440 362 306 9 440 362 356 9 440 362 368</p>	135 100 039
<p>passend für: T188</p>			
	<p>Förderpumpe V2 HO Friedmann & Maier Anschlüsse nach oben ohne Schauglas</p>	9 440 362 251	135 100 038
<p>passend für: T188</p>			
	<p>Förderpumpe Monark alternativ Anschlüsse müssen geändert werden</p>	135 100 040	
<p>▶ Handpumpe</p>		060 677 020	
<p>passend für: T188</p>			
	<p>Förderpumpe V2 HF01B Friedmann & Maier Anschlüsse seitlich mit Vorreiniger</p>	135 100 351	
<p>passend für: T190, T288, T290</p>			

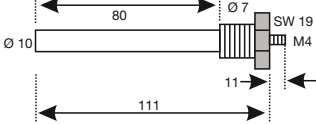
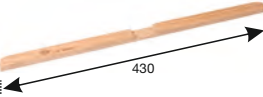
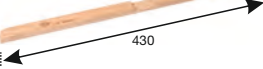
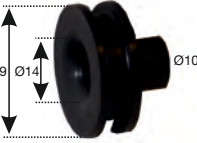

	Beschreibung	Referenz	Bestellnummer	Preis €
	Vorreiniger komplett		N172 000	
	Handpumpe für Förderpumpen Bosch und Friedmann-Maier		060 677 020	
	Rep.- Satz Vorreiniger Schauglas, Dichtung, Feder, Filter		N172 017	
	Förderpumpen - Repsatz für Friedmann-Maier Förderpumpe Serie V2 und V8		135 011 429	
	Förderpumpen - Repsatz für Bosch Förderpumpe		135 011 004	
	Dichtung für Förderpumpe (Bosch u. Friedmann-Maier) passend für: T80, u.v.a.		135 010 004	
	Düseneinsatz passend für: T80, T84, T86, T180/a, T185, T280 T188 T190, T288, T290		039 305 001 039 305 027 039 305 009	

Beschreibung	Referenz	Bestellnummer	Preis €
	Düsendichtring	135 010 732	
	passend für: T80, T84, T86, T180/a, T185, T280 T188, T190, T288, T290		
	Düseneinstellscheibe universal Ø 10 x 3 mm		
	0,05 mm Stärke 0,10 mm Stärke	135 801 004 135 801 005	
	Gummimuffe für Einspritzleitung 213 08 0076 Abmessung: Ø 39/15 x Ø 12/6 x 26mm	135 280 076	
	passend für: T80, T84, T86, u.a.		
	Schnellverbinder universal für Dieselleitung		
	M12 x 1,5 M14 x 1,5	135 011 507 135 011 508	
	Tankverschluss passend für: T80, T84, T86	180 55122	523 101 080
			
	Dichtung für Tankverschluss Abmessung: Ø 84 x Ø 60 x 3 mm	220 5515	503 019 844
	passend für: T80, T84, T86		
	Metallsieb	30 55116	16060-35-009
	passend für: T80, T84, T86, u.a.		

Beschreibung	Referenz	Bestellnummer	Preis €
 <p>Tankgeber</p> <p>passend für: T188, T190, T288, T290</p>	188 55 70	523 101 007	
			
 <p>Auflageleiste für Tank</p> <p>passend für: T80, T84, T86</p>	1 80 55021	523 101 021	
			
 <p>Gummimuffe für Kraftstoffleitung</p> <p>Abmessung: $\varnothing 39/15 \times \varnothing 14/10 \times 26\text{mm}$</p> <p>passend für: T80, T84, T86, u.a.</p>	213 A08 0021	523 101 821	
			

	Beschreibung	Referenz	Bestellnummer	Preis €
	Dieselfilter passend für: T80	180 55156	N0530-9	
	Dichtung für Dieselfilter N0530-9 passend für: T80, T84	180 55 0032 213 008 0059	135 010 002	
	Haltefeder für Dieselfilter passend für: T80, T84, T86, T180	180 55 50	501 190 002	
	Dieselfilter MANN & HUMMEL universal 1/2 Liter (Filz) 1/2 Liter (Papier) 1 Liter (Filz) 1 Liter (Papier)		501 200 011 501 200 012 501 200 013 501 200 014	
	Dichtung für Dieselfilter 1/2 Liter	610 0008 0712	503 019 856	
	Dichtung zwischen Filter und Tank Höhe: 1,5 mm passend für: T80/T84	180 55 0012	135 010 001	
	Ölfiltersatz passend für: T 188, T190, T290	406 07 0049	501 300 001	

Oldies Filter/Zubehör

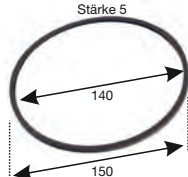
	Beschreibung	Referenz	Bestellnummer	Preis €
	Ölfiter passend für: T 290	409 07 0036	N0235	
	Regenkappe Abmessung: Ø 113 x 88 mm Rohr-Ø 50mm passend für: T80	80 19 0035	501 190 035	
	Regenkappe Abmessung: Ø 141 x 110 mm Rohr-Ø 50mm passend für: T84		501 190 036	
	Luftfilterkappe passend für: T86		501 190 006	
	Regenkappe passend für: T190, T288, teilweise T290		501 190 007	
	Ölbadluftfiltergehäuse passend für: T180a		501 190 005	
	Profiling für Ölbadfilter passend für: T80, T84, T86	1 80 19 0705	501 190 003	

Oldies Filter/Zubehör

Beschreibung

Referenz

Bestellnummer

Preis €

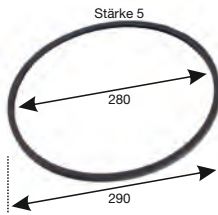

Profiling
für Ölbadfilter

1406 19704

501 190 004







passend für:
teilweise T190, T288, T290











Luftfilter
zum Umbau



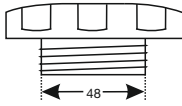

501 100 004

T180

	Beschreibung	Referenz	Bestellnummer	Preis €
	Wasserpumpe passend für: T80, T84, T86, T180/a, T182	213 A 0601	500 012 009	
	Dichtung für Wasserpumpe 500 012 009 passend für: T80, T84, T86, T180/a	213 06 15	503 019 829	
	Wasserpumpe ► Dichtung passend für: T188	1209 060604	500 012 011 503 191 852	
	Zulaufrohr für Wasserpumpe 500 012 011 ► O-Ring passend für: T188,	1 209 01 0079	500 013 079 500 013 004	
	Wasserpumpe passend für: T190, T288, T290	406A 060007 406 060901 1406A 060007	500 012 015	
	Kühler passend für: T180	180 5340 180 5342	500 011 007	
	Kühler kurzer Hals passend für: T80	84 5302 1 84 530002	500 011 080	

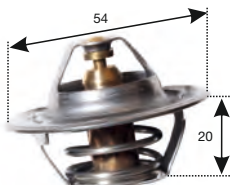
Oldies Kühlung

	Beschreibung	Referenz	Bestellnummer	Preis €
	Kühler langer Hals passend für: T84, T86	84 5304 1 84 530004	500 011 084	
	Kühler passend für: T188	1188 53 0027 1188 53 0031	500 011 188	
	Kühler passend für: T190/T288/T290	190 53 0010	500 011 013	 Bei Steyr T288/T290 muss unten ein flexibler Schlauch verwendet werden!
	Kühlerverschluss passend für: T80, T84, T86, T188	1377 0053 0702	N0272-1	
	Kühlerverschluss passend für: T80/T180		523 100 000	
	Lagerung für Kühler passend für: T80, T84, T86, T180/a	180 5318	503 019 897	
	Thermostat passend für: T80, T84, T86, T180, N180a, N182a, T188	180 5364	N0293-9	

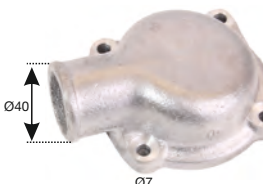
	Beschreibung	Referenz	Bestellnummer	Preis €
	<p>Thermostat 78°</p> <p>passend für: T188, T190, T288, T290</p>		500 011 204	
	<p>Thermostat 78°</p> <p>passend für: N180a, T180a, T182, T185, T280</p>	41 39 0428	500 011 205	
	<p>Kühlwasserrohr</p> <p>passend für: T80</p>	80 5302	500 013 080	
	<p>Kühlwasserrohr</p> <p>passend für: T180</p>		500 013 180	
	<p>Wasserrohr</p> <p>passend für: T180a</p>		500 013 181	
	<p>Deckel zum Wasserablaufrohr</p> <p>passend für: N180a, T180a, T182, T185, T280/a 380 LKW</p>	41 39 015	500 211 001	

Oldies Auspuff

Beschreibung	Referenz	Bestellnummer	Preis €
 <p>Auspuffkrümmer für 3-Zylinder</p> <p>passend für: T190</p>	307 11 0601 307 11 0004 1307 11 0601 1307 11 0004	526 200 006	
 <p>Auspufftopf schwarz lackiert Lochabstand: 88 mm (Loch außen)</p> <p>passend für: T180</p>	180 45 0027	526 200 180	
 <p>Auspufftopf nach oben schwarz lackiert Innen-Ø Eingang: 83 mm</p> <p>passend für: T80, T84</p>	80 54 0048 1 80 54 0048	526 200 080	
 <p>Auspufftopf nach unten schwarz lackiert Innen-Ø Eingang: 83 mm</p> <p>passend für: T80, T84</p>	84 54 0016 1 84 54 0016	526 200 084	
 <p>Dichtung für 526 200 080 und 084</p> <p>passend für: T80, T84</p>	1413C 110023	526 900 001	
 <p>Auspuffendrohr</p> <p>passend für: T80</p>		526 200 001	
 <p>Auspuffendtopf</p> <p>Stahl Niro</p> <p>passend für: T180a</p>	213a1112	526 200 011 526 200 012	

Oldies Auspuff/Kupplung

Beschreibung

Referenz

Bestellnummer

Preis €

Auspuffendrohr

526 200 002



passend für:
T180a

Auspuffendtopf

Eisen lackiert
Niro

526 200 007
526 200 008

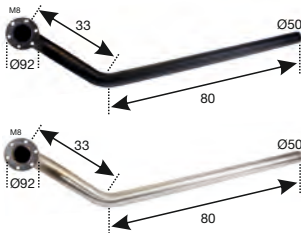

passend für:
T185, T280

Kupplung

Kupplungsscheibe starr

213 1603

520 001 180



Ø 280 mm, 10 Zähne 28/35
passt für OE Kupplungsscheibe mit
Ø 225 mm

passend für:
T180

Kupplungsscheibe

520 001 080



Ø 200 mm, 10 Zähne

passend für:
T80, T84, T86

Kupplungsscheibe

520 001 081



Ø 220 mm, 10 Zähne

passend für:
T80, T84, T86

Kupplungsscheibe

520 001 188



Ø 225mm 10 Zähne

passend für:
T188

Kupplungsscheibe starr

308 0016 0001









520 001 180

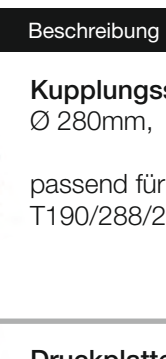

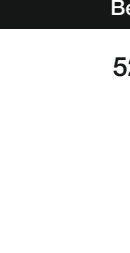
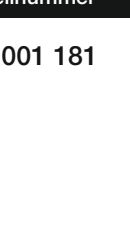

Ø 280mm, 10 Zähne 28/35

passend für:
T190 ab Fgst Nr: 11612
T288, T290

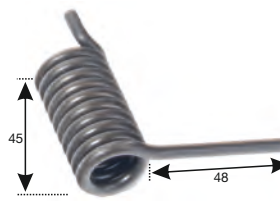

Oldies Kupplung

Beschreibung	Referenz	Bestellnummer	Preis €
 <p>Kupplungsscheibe gefedert Ø 280mm, passend für: T190/288/290</p>		520 001 181	
 <p>Druckplatte mit 3 Hebel ohne Kupplungsscheibe Ø 280 mm passend für: T80,s WD113 T84,a,e,s Wd113a T86 WD113a</p>		520 002 002	
 <p>Druckplatte Neu mit 3 Hebel ohne Kupplungsscheibe Ø 280 mm</p>	406 160 901	520 002 003	
 <p>Druckplatte Sachs Tausch passend für: T190 WD307 ab Fgst Nr 11612 T288 WD406 T290 WD406a</p>		520 002 001 Kaution	
 <p>Drucklager passend für: T80, T84, T86</p>		520 003 003	 Drucklager nur mit Adapter 520 004 003 verwendbar!
 <p>Adapter für Drucklager passend für: T80, T84, T86</p>		520 004 003	
 <p>Drucklager Sachs passend für: 190/288/290</p>		520 003 002	
 <p>Rückzugsfeder für Kupplungspedal passend für: T180a/T182</p>	180 35 14 170 23 12	523 100 004	

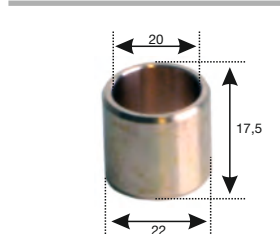



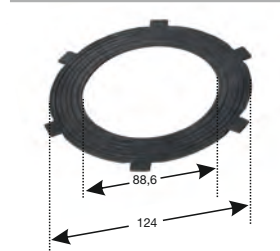

Oldies Getriebe/Zapfwelle

	Beschreibung	Referenz	Bestellnummer	Preis €
 <p>45 48</p>	<p>Anschlagfeder für Schalthebel</p> <p>passend für: T180</p>	380 92 410	520 006 011	
	<p>Gummikappe für Schaltdeckel Abmessung: Ø 83 x Ø 45/12 x 65mm</p> <p>passend für: T80, T84, T86 u.a.</p>	270 24 0038	520 006 038	
 <p>SW 22 M38 x 1,5</p>	<p>Ölablassschraube Getriebe</p> <p>▶ Kupferscheibe 38 x 44 x 2 mm</p> <p>passend für: T80, T84, T86, T180</p>		520 006 903	520 006 904
 <p>20 17,5 22</p>	<p>Buchse für Zapfwelle und Getriebe</p> <p>passend für: T80, T84, T86</p>	80 22 0014	520 006 114	

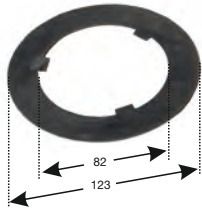



Zapfwelle





	<p>Zapfwellenschutz</p> <p>passend für: T80, T84, T86</p>		N1415	
<p>i Zapfwellenschutz nur mit Adapter N1415-9 verwendbar!</p>				
	<p>Adapter für Zapfwellenschutz N1415</p> <p>passend für: T80, T84/, 86</p>		N1415-9	
 <p>88,6 124</p>	<p>Lamelle für Zapfwellenkupplung</p> <p>passend für: T190, 430, 540, 545, 650</p>	188 22 0017	520 004 051	

Oldies Zapfwelle/Mähwerk

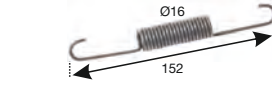
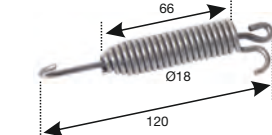

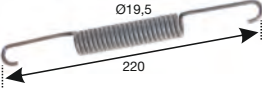

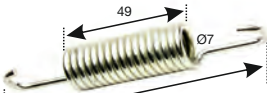

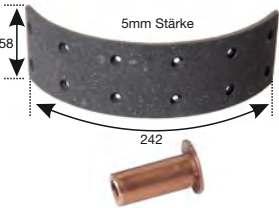
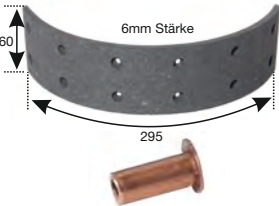
	Beschreibung	Referenz	Bestellnummer	Preis €
	<p>Lamelle für Zapfwellenkupplung</p> <p>passend für: T190</p>	188 22 0016	520 004 052	
	<p>Kupplungshandhebel für Doppel Trocken Kupplung und Lamellenkupplung</p> <p>passend für: T288, T290</p>	292 27 0099 288 0024 0030	520 004 020	
Mähwerk				
	<p>Dichtung für Mähbalkenantrieb</p> <p>passend für: T180</p>	180 33 37	503 191 814	
	<p>Verschlusskappe Mähwerk mit Ablassschraube, ohne Dichtung</p> <p>passend für: T80, T84, T86</p>	180 21 0005	520 006 002	
	<p>Dichtung für Verschlusskappe Mähwerk</p> <p>passend für: T80, T84, T86</p>	180 21 0006	520 006 902	
	<p>Ölablassschraube Mähwerk</p> <p>▶ Kupferscheibe 38 x 44 x 2 mm</p> <p>passend für: T80, T84, T86, T180</p>		520 006 903 520 006 904	

Oldies Bremse

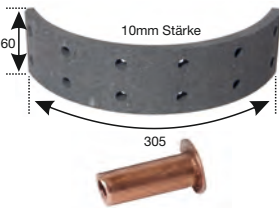





	Beschreibung	Referenz	Bestellnummer	Preis €
	<p>Bremsbacken Tausch</p> <p>Belaghöhe: 8 mm Belagbreite: 70 mm</p> <p>passend für: T180 ältere Ausführung</p>		<p>N2006-12</p> <p>Kaution</p>	
	<p>Bremsbacken Tausch</p> <p>Belaghöhe: 9,3 mm Belagbreite: 80 mm</p> <p>passend für: T180 neuere Ausführung (Alu)</p>		<p>N2006-11</p> <p>Kaution</p>	
	<p>Bremsbacken Tausch</p> <p>Belaghöhe: 8 mm Belagbreite: 60 mm</p> <p>Lange Version Kurze Version</p> <p>passend für: T180a, T182, T185</p>		<p>N2006-13A N2006-13B</p> <p>Kaution</p>	
	<p>Bremsbacken Tausch</p> <p>Belaghöhe: 9,3 mm Belagbreite: 80 mm</p> <p>passend für: T180 ältere Ausführung</p>		<p>N2006-10</p> <p>Kaution</p>	
	<p>Bremsbacken Tausch</p> <p>Belaghöhe: 6 mm Belagbreite: 60 mm</p> <p>passend für: T80 neuere Ausführung</p>		<p>N2006-9</p> <p>Kaution</p>	
	<p>Bremsfeder</p> <p>passend für: T80 bei Bremsband T180 ab Fgst-Nr. 9001</p>	<p>13809 0340115</p>	<p>524 214 004</p>	
	<p>Bremsfeder mit beweglicher Öse</p> <p>passend für: T180a, T182, T185</p>	<p>1180A 340024</p>	<p>524 214 006</p>	

Beschreibung	Referenz	Bestellnummer	Preis €
 <p> Bremsfeder für Bremsbacken passend für: T180a, T182, T185 </p>	1180A 340026	524 214 005	
 <p> Bremsfeder für Bremsbacken passend für: T80 neuere Ausführung </p>		524 214 057	
 <p> Bremsfeder passend für: T188 </p>	188 34 16 1188340016	524 900 016	
 <p> Bremsfeder passend für: T288, T290 </p>	288 340042	N2008	
 <p> Bremselag hinten hinten passend für: T188 ► Niete 4 x 10 mm (VPE 100 Stk) </p>	1 92 34 1001 92 34 0007	524 212 002	524 219 001
 <p> Bremselag hinten passend für: T190 ► Niete 4 x 10 mm (VPE 100 Stk) </p>	190 34 0072 1190 341001	524 212 003	524 219 001
 <p> Bremselag hinten passend für: T288/290 bis Fgst. Nr 1500 ► Niete 4 x 10 mm (VPE 100 Stk) </p>	288 34 0065 1288 34 0701	524 212 004	524 219 001

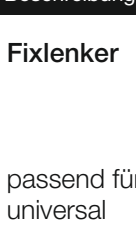
Oldies Brems-/Lenkung

	Beschreibung	Referenz	Bestellnummer	Preis €
	Bremsbelag hinten passend für: T288/290 ab Fgst. Nr 1501 ▶ Niete 4 x 12 mm (VPE 100 Stk)	295 34 0010 1295 34 0801 190003913561	524 212 005 524 219 002	
	Rückzugsfeder für Bremspedal passend für: T180a/T182	170 23 12	523 100 004	
	Lenkrad Original mit Stahlnabe passend für: T80, T84, T180/a, T182a		N2075-7	
	Lenkrad Nachbau mit Gussnabe passend für: T80, T84, T180/a, T182a		N2075-9	
	Lenkrad passend für: T185, T280		N2075-8	
	Lenkrad passend für: T86, T188, T190, T288, T290		N2075-5	
	Abdeckkappe für Lenkräder: N2075-7, N2075-9, N2075-8, N2075-5		N92470003	

Oldies Lenkung

	Beschreibung	Referenz	Bestellnummer	Preis €
	Fixlenker passend für: universal		093 199 202	
	Buchse für Lenksäulenrohr oben passend für: T80/T84/T86	180 047 0008	522 300 008	
	Gummitülle für Lenksäulenrohr Abmessung: Ø 59 x Ø 38 x 13 mm passend für: T80, u.a.	180 A47 0014	522 301 714	
	Buchse für Lenkung passend für: T80/T180	180 21 0025	522 300 025	
	Kronenmutter passend für: T80/T84/T86	80 41103	522 301 103	
	Kronenmutter für Achsschenkel M22x1,5 passend für: T180	180 041 094	522 300 094	
	Staubkappe für Lenkhebel Abmessung: Ø 36 x Ø 13 x 14 mm passend für: T80	80 43 0014	522 301 314	

FAHRZEUGTEILE

Beschreibung	Referenz	Bestellnummer	Preis €
Staubkappe für Lenkhebel Abmessung: Ø 36 x Ø 17 x 15mm  passend für: T180/a	180 43 0020	522 301 320	
 Kugelbolzensatz für Spur und Schubstange Kugel Ø 20mm passend für: T80, T84 teilweise T180	180 43 0007	522 100 030	
 Kugelbolzensatz für Spur und Schubstange Kugel Ø 24mm passend für: T180/a, T182, T185	11800 430009	522 100 035	
 Kugelgelenk M22 x 1,5 R 16,2 -18,3 passend für: T190	1192 43 0735 1192 43 0087 1292 430 721 1190 430 700	522 300 735	
 Kugelgelenk M22 x 1,5 L 16,2 -18,3 passend für: T190	1192 43 0741 1292 43 0721 1292 43 0087	522 300 741	
 Unterlenkerkugel d: 25,5mm D: 50,5mm H: 32mm d: 28,5mm D: 55,5mm H: 35mm d: 28,5mm D: 50,5mm H: 32mm passend für: T80, T84, T86, T180 u.v.a.	1 80 740051	522 300 002 522 300 003 522 300 004	
 Rückholfeder Lenkbremshebel links rechts passend für: T180	180 35 0013 180 35 0024	522 300 013 522 300 024	

Beschreibung

Referenz

Bestellnummer

Preis €

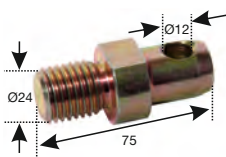

Unterenkerbolzen
Bremsstrommelseitig

522 100 068

passend für:
T80, T84, T86

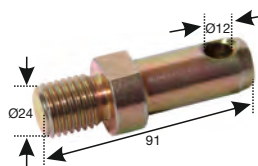

Unterenkerbolzen
Differenzialgehäuseseitig

522 100 069

passend für:
T80, T84, T86

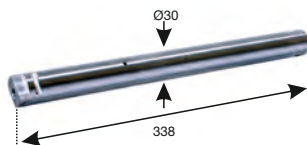

Mittelachsbolzen

80 041 0053
80 4153

522 100 053

passend für:
T80/T180



Sicherungsblatt
für Vorderachsbolzen

180 041 0070
180 4170

522 100 070

passend für:
T80/T180



Buchse
für Mittelachsbolzen

180 041 0102
180 4102

522 100 102

passend für:
T80/T84/T86/T180

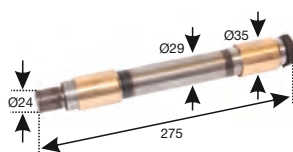

Mittelachsbolzen
mit Büchsen
für 6 Gang

180a4150

522 100 027

passend für:
T180/a

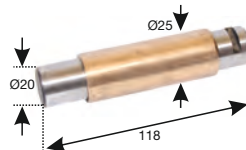

Federbolzen komplett mit Buchse
Standard
für gefederte Vorderachse



180 041 0007
180 041 0004



522 100 028

passend für:
T180/a, T182, T185

Oldies Achse

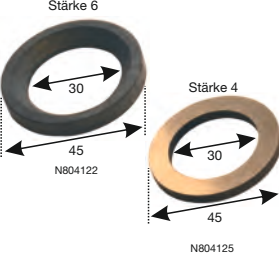
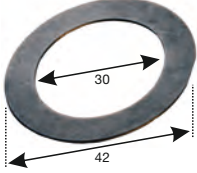
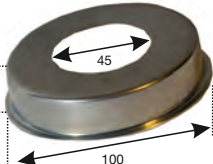
Beschreibung	Referenz	Bestellnummer	Preis €
	Federbolzen einzeln für gefederte Vorderachse	180 041 0004	522 180 204 522 180 004
	Buchsen einzeln für gefederte Vorderachse	180 041 0007	522 180 207 522 180 007
	Federbolzen mit Büchse		522 100 028
	Achsschenkel	180410107	522 100 107
	Achsschenkelbuchse unten für Vorderachse	180 041 0021	522 101 021
	Achsschenkelbuchse oben für Vorderachse	180 041 0076	522 101 076
	Achsschenkelbuchse Material: CARO-Bronze (OE)	380 941 0024	522 101 024

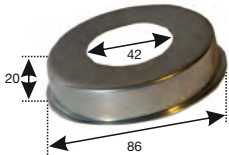
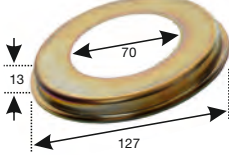
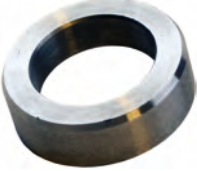
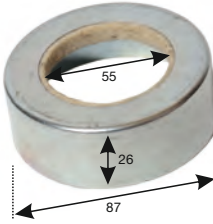
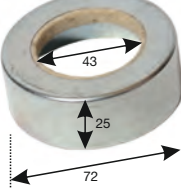
	Beschreibung	Referenz	Bestellnummer	Preis €
	<p>Achsschenkelbuchse oben Material: CARO-Bronze (OE)</p> <p>bis Fgst Nr.: 10127 Ø 32 x Ø 38 x 55 mm</p> <p>von Fgst Nr.: 10128 bis 14905 Ø 35 x Ø 42 x 55 mm</p> <p>ab Fgst Nr.: 14906 Ø 35 x Ø 40 x 55 mm</p> <p>passend für: T188</p>	<p>188 41 0059</p> <p>188 41 0172</p> <p>188 41 0058</p>	<p>522 101 059</p> <p>522 101 172</p> <p>522 101 058</p>	
	<p>Achsschenkelbuchse unten Material: CARO-Bronze (OE)</p> <p>passend für: T188</p>	<p>188 41 0058</p>	<p>522 101 058</p>	
	<p>Keilbolzen</p> <p>passend für: T80/T84/T86</p>	<p>80 4124</p>	<p>500 100 124</p>	
	<p>Anlaufscheibe</p> <p>unten oben</p> <p>passend für: T80, T84, T86</p>	<p>80 4122</p> <p>80 4125</p>	<p>500 100 122</p> <p>500 100 125</p>	
	<p>Einstellscheibe</p> <p>0,5mm 1,0mm</p> <p>passend für : T80/84/86</p>	<p>80 4133</p> <p>80 4134</p>	<p>500 100 133</p> <p>500 100 134</p>	
	<p>Labyrinthblech</p> <p>passend für: T180/a</p>	<p>180 4146</p>	<p>522 100 146</p>	

	Beschreibung	Referenz	Bestellnummer	Preis €
	Labyrinthblech passend für: T80, T188	80 4118	522 100 118	
	Labyrinthblech passend für: T185, T280	280 4136	522 100 003	
	Anlauftring passend für: T80, T84, T86	80 4113	522 100 113	
	Dichtungstopf mit Filz passend für: T180/a	180 4142	522 100 005	
	Dichtungstopf mit Filz passend für: T80, T84, T86	80 4114	522 100 004	
	Dichtung für Radkasten passend für: T188		503 191 851	
	Bremswellenfeder Portalachse passend für: T188	188 3421	524 214 003	

	Beschreibung	Referenz	Bestellnummer	Preis €
	Hydraulikpumpe passend für: T190 T190s ab Motor Nr.: 4600	0 510 520 309 0 510 525 335 0 510 525 311	521 010 004	
	Hydraulikpumpe passend für: T185/a, T280/a	131T1300101 0 510 520 011 0 510 525 010	521 010 010	
	Hydraulikpumpe passend für: 288, 290	0 510 625 315	521 010 002	
	Dichtung hinten für Hydraulikgehäuse passend für: T80, T84, T86, T180	80 73 61 1 80 730061	503 019 840	
	Dichtung vorne für Hydraulikgehäuse passend für: T80, T84, T86, T180	80 73 05 1 80 730092	503 019 841	
	Dichtung Papier passend für: T80, T84, T86, T180	80 73 05 1 80 730005	503 019 842	
	Reparatursatz Gelenkstück Standard mit 16mm Bolzen Übermaß mit 18mm Bolzen passend für: T188, T190 für kleines Hubwerk	188 47 18	522 200 418 522 200 419	

Beschreibung

Referenz

Bestellnummer

Preis €

Zusatzsteuergerät

397 73 0174

522 201 174

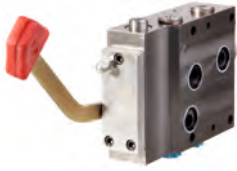

passend für:
T190, T288, T290

Gelenkstück

190 74 0196

522 200 011

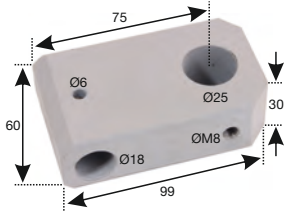

passend für:
teilweise T190, T288, T290

Gelenkstück

292 74 0078

522 200 010

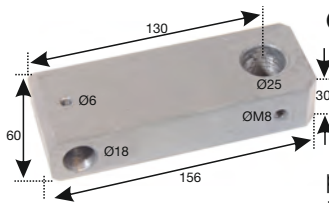

passend für:
teilweise T190, T288, T290

Ackerschiene

1 80 740134

522 200 003

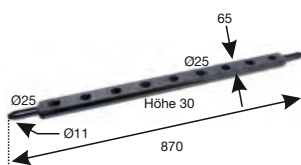

passend für:
T80

Anhängermaul

180a 9336

523 130 101

Bolzen von oben mit Nagel



passend für:
T80, T80s, 180/a

i Grundiert!

Steckbolzen

180a 9323

523 130 004

für 523 130 101



passend für:
T80, T80s, 180/a

Anhängermaul

80a 9311

523 130 001









passend für:
T80a



i Grundiert!

Beschreibung	Referenz	Bestellnummer	Preis €
 <p>Sicherungsbolzen für 523 130 001, 523 130 101</p> <p>passend für: T80a, T180/a</p>	80a 9311	523 130 005	

Oldies Karosserie

	Beschreibung	Referenz	Bestellnummer	Preis €
	STEYR Diesel, rechts 230 x 60/125 mm	T80, T84	N72013RE	
	STEYR Diesel, links 230 x 60/125 mm	T80, T84	N72013LI	
	STEYR Diesel, gerade 340 x 65 mm	T180/a, T182, T185, T280	N72014	
	STEYR Klasse I 180 x 100 mm	T80, T180/a, T182, T185, T280	N72012	
	STEYR Klasse II 180 x 100 mm	T84, T180/a T185, T280	N72016	
	STEYR „Made in Austria“ 80 x 41 mm	T84, T180/a, T185, T280	N72017	
	STEYR „II“ 75 x 100 mm	T84, T180/a T185, T280	N72018	
	Typenschild Abmessung: 145 x 50mm unbeschlagen		130 320 001	





Oldies Karosserie

Beschreibung	Referenz	Bestellnummer	Preis €
 Schriftzug Steyr T80		130 310 080	
 Schriftzug Steyr T84		130 310 084	
 Schriftzug Steyr T180		130 310 180	
 Schriftzug Steyr T180a		130 310 181	
 Schriftzug Steyr T188		130 310 188	
 Schriftzug Steyr T190		130 310 190	
 Typenschild T80/180 klein		130 311 001	
 Typenschild T180a/185/280 groß		130 311 002	



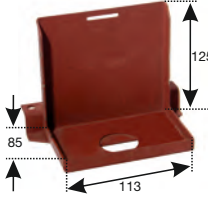
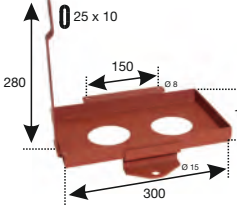
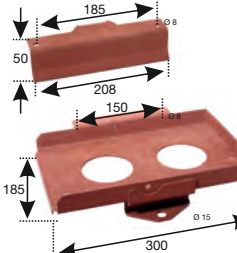
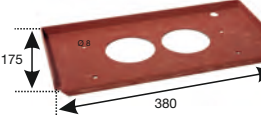



Oldies Karosserie

Beschreibung	Referenz	Bestellnummer	Preis €
 <p>Emblem</p> <p>passend für: T180</p>	181 7718	130 330 180	
 <p>Emblem</p> <p>passend für: T80/T84</p>		130 330 084	
 <p>Emblem</p> <p>passend für: T188</p>		130 330 188	
 <p>Zierleiste bei Motorhaube</p> <p>passend für: T188, T280, T288, T290</p>	<p>i Leiste muss erhitzt und dann der Motorhaube nachgebogen werden!</p>	523 100 075	
 <p>Haubenhalter</p> <p>Klein 65 mm Groß 120 mm</p>		523 100 010	523 100 011
 <p>Batteriekasten</p> <p>passend für: T180</p>		523 100 008	
 <p>Verschlussfeder für 523 100 008</p>		523 100 029	

Oldies Karosserie

	Beschreibung	Referenz	Bestellnummer	Preis €
 <p>Technical drawing of a red battery holder for a 6V battery. Dimensions: height 125, width 113, depth 85.</p>	<p>Batteriehalterung alte Ausführung für 6 Volt Batterie</p> <p>passend für: T80</p>	80 7633	523 100 014	
 <p>Technical drawing of a red battery holder for a 12V battery. Dimensions: height 280, width 300, depth 180. Hole diameter $\varnothing 8$. Mounting hole diameter $\varnothing 15$. Flange width 25 x 10.</p>	<p>Batteriehalterung für 12 Ausführung bis Fgst Nr 55975</p> <p>passend für: T80, T84</p>	80 7640	523 100 016	
 <p>Technical drawing of a red 2-piece battery holder for a 12V battery. Dimensions: top part width 185, height 50; bottom part width 300, height 185. Hole diameter $\varnothing 8$. Mounting hole diameter $\varnothing 15$. Flange width 25 x 10. Total length 208.</p>	<p>Batteriehalterung 2-teilig für 12 Volt Ausführung ab Fgst Nr.: 55976</p> <p>passend für: T80, T84</p>	84 7606 84 7610	523 100 015	
 <p>Technical drawing of a red battery holder for T180a. Dimensions: height 175, width 380. Hole diameter $\varnothing 8$.</p>	<p>Batteriehalterung</p> <p>passend für: T180a</p>	180a 7620	523 100 017	
 <p>Image of a red diamond-plate tread plate.</p>	<p>Trittlech</p> <p>passend für: T80, T84, T86</p>	81 25 0234	523 100 234	
 <p>Image of a red diamond-plate tread plate, left side.</p>	<p>Trittlech links</p> <p>passend für: T84 , T80 zum Nachrüsten</p>	85 2707	523 100 018	
 <p>Image of a red diamond-plate tread plate, right side.</p>	<p>Trittlech rechts</p> <p>passend für: T84, T80 zum Nachrüsten</p>	85 2703	523 100 019	

Oldies Karosserie

	Beschreibung	Referenz	Bestellnummer	Preis €
	Werkzeuglade passend für: T180	180 55 0004 1180 55 0004	523 100 604	
	Werkzeugkasten passend für: T80	84 5517 84 5531 84 5590	523 100 074	
	Werkzeugkastentür Abmessung: 155 x 165 mm passend für: T180a, T182, T182a, T280a, N180a	181A1309	523 100 309	
	Verschlussfeder für Werkzeugkiste passend für: T188, T190, T288, T290		523 100 029	
	Gaspedal passend für: T84/T86		523 100 001	
	Rückzugsfeder für Gasgestänge (Pedal) passend für: bei T84/T86	180 35 14	523 100 004	
	Sitzgummipuffer Abmessung: Ø 70/48 x 53mm passend für: T80 u. a. Steyr Oldies	81 51 0008	523 150 008	

Oldies Karosserie

Beschreibung

Referenz

Bestellnummer

Preis €



Spiegel

130 020 310

passend für:
T180, T80, T84, T86 u.a.

Spiegelstange

130 299 001

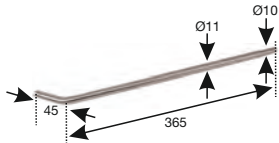

passend für:
T180, T80, T84, T86 u.a.

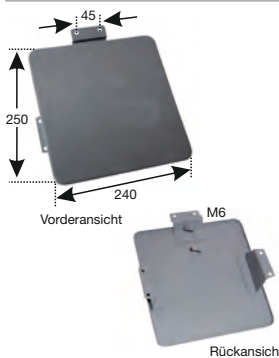

Kennzeichen-Halterung

523 100 020

für Montage hinter dem Fahrersitz
mit Halterung für Kennzeichen-
Beleuchtung

passend für:
T80, T84



Kennzeichen-Halterung

523 100 021

für Montage hinter dem Kotflügel
ohne Halterung für Kennzeichen-
Beleuchtung

passend für:
T80, T84



Kennzeichen-Halterung

523 100 022

passend für:
T180/a, T185/a, T280/a





Oldies Karosserie







Beschreibung	Referenz	Bestellnummer	Preis €
 <p>Vorderansicht Rückansicht</p>	Kennzeichen-Halterung mit Haltung für Kennzeichen- Beleuchtung	523 100 023	
	Lampenhalterung passend für: T180a	181A7605 817 658	523 100 068
	Lampenhalterung passend für: T180		523 100 069
	Lampenhalterung passend für: T80, T84		523 100 024
	Lampenhalterung links passend für: T80, T84		523 100 025
	Halterung für Rückleuchte passend für: T80, T84, T180/a		100 550 018







Oldies Karosserie

Beschreibung	Referenz	Bestellnummer	Preis €
	<p>Halterung für Steckdose</p> <p>passend für: T80</p>		523 100 002
	<p>Sitzkissen</p> <p>passend für: T80</p>		523 150 080
	<p>Sitzkissen</p> <p>passend für: T188</p>		523 150 188
	<p>Sitzkissen</p> <p>passend für: T190</p>		523 150 190
	<p>Kotflügel mit Lehne hinten</p>	523 140 505	
	<p>Links Rechts</p>	523 140 506	
	<p>passend für: T80, T84, T86</p>		



Beschreibung	Referenz	Bestellnummer	Preis €																																																			
	Lichtmaschine																																																					
BOSCH Tausch 12V 16A		N395035																																																				
passend für:		Kaution																																																				
<table border="0"> <tr><td>30</td><td>WD210</td><td>1966-1971</td></tr> <tr><td>40</td><td>WD310</td><td>1967-1970</td></tr> <tr><td>50</td><td>WD407</td><td>1967</td></tr> <tr><td>60</td><td></td><td></td></tr> <tr><td>70</td><td>WD410</td><td>1968-1970</td></tr> </table>	30	WD210	1966-1971	40	WD310	1967-1970	50	WD407	1967	60			70	WD410	1968-1970																																							
30	WD210	1966-1971																																																				
40	WD310	1967-1970																																																				
50	WD407	1967																																																				
60																																																						
70	WD410	1968-1970																																																				
	Alternator	3113331R92																																																				
LETRIKA (Iskra) 14V 33A		IA0067																																																				
▶ Anschlussstecker 3 Polig	 Zum Umbau von Gleichstrom auf Wechselstrom!	345 003 001																																																				
	Alternator																																																					
LETRIKA (Iskra) 14V 33A	1311 0009 0005	IA0062																																																				
▶ Anschlussstecker 2 Polig (für IA0062)		345 002 002																																																				
passend für:																																																						
<table border="0"> <tr><td>90</td><td>WD610</td><td>1968-1970</td></tr> <tr><td>430</td><td>WD210</td><td>1976</td></tr> <tr><td>540</td><td>WD308.40</td><td>1971-1977</td></tr> <tr><td>545</td><td>WD308</td><td>1972-1977</td></tr> <tr><td>548</td><td>WD308.45</td><td>1977-1981</td></tr> <tr><td>650</td><td>WD408.81</td><td>1971-1977</td></tr> <tr><td>658</td><td>WD408.42</td><td>1977-1979</td></tr> <tr><td>760</td><td>WD210.40</td><td>1971-1976</td></tr> <tr><td>768</td><td>WD408.43</td><td>1977-1979</td></tr> <tr><td>870</td><td>WD410.40</td><td>1971-1975</td></tr> <tr><td>980</td><td>WD412.40</td><td>1977-1979</td></tr> <tr><td>988</td><td></td><td></td></tr> <tr><td>1090</td><td>WD610</td><td>1968-1972</td></tr> <tr><td>1100</td><td>WD610.40</td><td>1971-1977</td></tr> <tr><td>1108</td><td>WD610.44</td><td>1977-1979</td></tr> <tr><td>1200</td><td>WD610.41</td><td>1972-1975</td></tr> <tr><td>1400</td><td>WD612.85</td><td>1974-1979</td></tr> </table>	90	WD610	1968-1970	430	WD210	1976	540	WD308.40	1971-1977	545	WD308	1972-1977	548	WD308.45	1977-1981	650	WD408.81	1971-1977	658	WD408.42	1977-1979	760	WD210.40	1971-1976	768	WD408.43	1977-1979	870	WD410.40	1971-1975	980	WD412.40	1977-1979	988			1090	WD610	1968-1972	1100	WD610.40	1971-1977	1108	WD610.44	1977-1979	1200	WD610.41	1972-1975	1400	WD612.85	1974-1979			
90	WD610	1968-1970																																																				
430	WD210	1976																																																				
540	WD308.40	1971-1977																																																				
545	WD308	1972-1977																																																				
548	WD308.45	1977-1981																																																				
650	WD408.81	1971-1977																																																				
658	WD408.42	1977-1979																																																				
760	WD210.40	1971-1976																																																				
768	WD408.43	1977-1979																																																				
870	WD410.40	1971-1975																																																				
980	WD412.40	1977-1979																																																				
988																																																						
1090	WD610	1968-1972																																																				
1100	WD610.40	1971-1977																																																				
1108	WD610.44	1977-1979																																																				
1200	WD610.41	1972-1975																																																				
1400	WD612.85	1974-1979																																																				
	Keilriemen																																																					
passend für:																																																						
540, 545, 650, 760	9,5 x 1200 mm	097 101 200																																																				
430, 548, 568, 768	9,5 x 1275 mm	097 101 275																																																				
980, 1108	9,5 x 1350 mm	097 101 350																																																				
1090, 1200	9,5 x 1375 mm	097 101 375																																																				
1400	9,5 x 1325 mm	097 101 325																																																				









	Beschreibung	Referenz	Bestellnummer	Preis €
	Regler für Bosch/Iskra Alternator 33A		H130507	
	Gummipfeife für Anschlüsse		ME006038.00	
	Starter LETRIKA (Iskra) 12V 2,7 KW 9Z UMLAUFF 12V 2,7 KW 9Z BOSCH Tausch 12V 2,7 KW 9Z passend für: 30 WD210 1966-1971 40 WD307 1967-1970 430 WD210 1976 540 WD308.40 1971-1977 545 WD308 1972-1977 548 WD308.45 1977-1981 658 WD408.42 1977-1979 768 WD408.43 1977-1979	308 0009 001	IS0548 AIS0548	
 Auf Anfrage auch mit 9 Volt Anker lieferbar – für 1/3 mehr Drehmoment!	990644 Kaution			
	Starter LETRIKA (Iskra) 12V 3,0 KW 11Z UMLAUFF 12V 3,0 KW 11Z BOSCH Tausch 12V 3,0 KW 11Z passend für: 50 WD407 1967 650 WD408.81 1971-1977 760 WD210.40 1971-1976 988 WD412.41 1977-1979	408 0009 0901 308 0009 0017 412 0009 0001 412 0009 004	IS0201 N291201	
 Auf Anfrage auch mit 9 Volt Anker lieferbar – für 1/3 mehr Drehmoment!	990253 Kaution			

	Beschreibung	Referenz	Bestellnummer	Preis €
	Starter	409 090 001		
	LETRIKA (Iskra) 12V 3,0 KW 11Z	412 0009 0001 412 0009 0004	IS0821	
	BOSCH Tausch 12V 3,0 KW 11Z		990864 Kaution	
	passend für:			
	70 WD410 1968-1970			
	90 WD610 1968-1970			
	870 WD410.40 1971-1975			
	980 WD412.40 1974-1977			
	1090 Wd610 1968-1972			
	1100 WD610.40 1971-1977			
	1200 WD610.41 1972-1975 WD610.43			
	Starter	412 0009 0001 412 0009 0004	IS0751	
	LETRIKA (Iskra) 12V 3,0 KW 9Z			
	BOSCH Tausch 12V 3,0 KW 9Z		990140 Kaution	
	passend für:			
	1108 WD610.40 1977-1979			
	1400 WD612.85 1974-1979			
	Gummipfeife für Starter	213 009 0030	N2803-1	
	Zugstartschalter Schraubanschluss	192 58 0008	N2684	
	Zugstartschalter Steckanschluss		350 883 009	
	Zünd-, Lichtschalter	317 0058 0002	N2682	
	Original Qualität		083 872 012	
	Lenkstockscharter für Lenkstange Ø 45 mm	390 58 0058	350 881 002	

i Auf Anfrage auch mit 9 Volt Anker lieferbar – für 1/3 mehr Drehmoment!

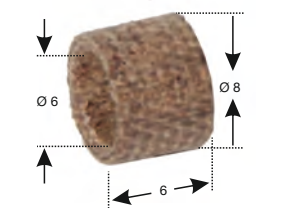
Beschreibung	Referenz	Bestellnummer	Preis €
 <p>Bremslichtschalter Druck aus</p>		100 900 704	
 <p>Öldruckschalter M10 x 1</p>		N600007	
 <p>Batteriedeckel Länge 270 mm Länge 320 mm</p>	292 76 0007	N2775 N2775-1	
 <p>Kralle für Batteriedeckel</p>	192 25 0217	N2776	
 <p>Kabelstrang</p>	93 70 0053	N3120	
 <p>Sicherungsdose</p> <ul style="list-style-type: none"> ▶ Keramiksicherung 5A ▶ Keramiksicherung 8A ▶ Keramiksicherung 16A ▶ Keramiksicherung 25A 	92 58 0008	N2690 HB50 295 032 HB50 295 034 HB50 295 035 HB50 295 036	
 <p>Tellerhorn 12 Volt</p>		LEK 91-12V	

Plus Serie Elektrik

	Beschreibung	Referenz	Bestellnummer	Preis €
	Stecker 7-polig 12V mit Schraubanschlüssen		ME005167.00	
	Steckdose 7-polig 12V mit Schraubanschlüssen		ME004317.00	
	Vorglühschleife	210 09 0008	N0625	
	Isolierung	180 058 0031	N0629	
	Hülse für Glühanlage	407 09 0006	351 990 001	
	Fernthermometer Ø 52 mm	192 58 0040	N2667	
	Distanzring für Fernthermometer von Ø 52 mm auf Ø 60 mm		N3430	
	Geber für Fernthermometer		N2668B	
	Traktormeter Ø 80 mm	337 0058 00667	N2675	

Plus Serie Elektrik

Beschreibung	Referenz	Bestellnummer	Preis €
	Dichtgummi für Traktormeter	N2675-8	
	Traktormeterwelle Länge 1700 mm	190 58 0061	N2679
	Winkeltrieb	92 58 0016	N2680
	Kuppler	192 00 5836	N2681
	Wischermotor 85°	093 210 001	
	Wischermotor 110°	093 210 003	
	Wischerarm 450 mm	093 230 045	
	Wischerblatt gerade nicht gefedert 360 mm 400 mm	093 257 360	093 257 400
	Wischerblatt gefedert	(Paar)	3 397 118 610
	400 mm	(Paar)	3 397 118 505
	450 mm	(Paar)	3 397 118 560
	500 mm		

Plus Serie Elektrik

Beschreibung

Referenz

Bestellnummer

Preis €

Adapter
für Wischerblätter von Alt auf Neu

523 401 088



Scheibenwaschbehälter
Set mit Pumpe, Düse und Zubehör

523 100 003



Kühlwasservorwärmer

350 212 312

Plus Serie Beleuchtung

Beschreibung

Referenz

Bestellnummer

Preis €

Kühlergrill mit Scheinwerfern

N2919-1

zum Umbau auf H4 Scheinwerfer
(ohne Einbausatz)



Einbausatz

N2919-2



Emblem

N2920

Scheinwerfer H4







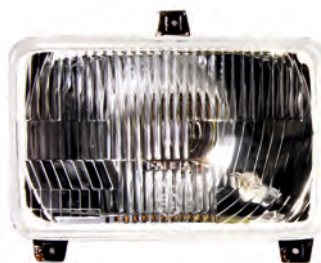



N2732

▶ Ersatzlampe H4









091 412 004



Plus Serie Beleuchtung

	Beschreibung	Referenz	Bestellnummer	Preis €
	Hauptscheinwerfer	93 72 0005	100 400 100	
	▶ Ersatzlampe 12V 45/40 Watt		LK 14732	
<hr/>				
	Blink-, Begrenzugsleuchte rechts	93 73 0011	N2781	
	▶ Kugellampe 12V 21W Ba15s ▶ Kugellampe 12V 21/5W Ba15S		091 612 010 091 612 008	
	▶ Lichtscheibe links	93 73 0700	N2782	
	▶ Lichtscheibe gelb	93 76 0706	N2789	
<hr/>				
	Blink-, Begrenzugsleuchte rechts	93 73 0012	N2784	
	▶ Kugellampe 12V 21W Ba15s ▶ Kugellampe 12V 21/5W Ba15S		091 612 010 091 612 008	
	▶ Lichtscheibe links	93 73 0701	N2786	
	▶ Lichtscheibe gelb	93 73 0704	N2788	
<hr/>				
	Schluss-, Brems-, Blinkleuchte rechts	93 76 0067	N2793	
	▶ Kugellampe 12V 21W Ba15s ▶ Kugellampe 12V 21/5W Ba15S		091 612 010 091 612 008	
	▶ Lichtscheibe rechts	93 73 0702	N2795	
	▶ Lichtscheibe gelb rechts	93 73 0704	N2788	

Plus Serie Beleuchtung

	Beschreibung	Referenz	Bestellnummer	Preis €
	Schluss-, Brems-, Blinkleuchte links	93 76 0068	N2794	
	<ul style="list-style-type: none"> ▶ Kugellampe 12V 21W Ba15s ▶ Kugellampe 12V 21/5W Ba15s 			091 612 010 091 612 008
	▶ Lichtscheibe links	93 73 0703	N2796	
	▶ Lichtscheibe gelb links	93 76 0706	N2789	
	▶ Lichtscheibe weiß links	93 73 0707	N2799	
	Rückstrahler für Rückleuchte	93 76 0705	N2803	
	Kontrollleuchtenleiste 10-Polig	337 0058 0063	N2715	
	<ul style="list-style-type: none"> ▶ Fassung (Schraubanschluß) ▶ Ersatzlampe 12V/2W Ba9s 			100 900 042 091 712 028
	Arbeitsscheinwerfer mit Schalter		100 500 100	
	▶ Ersatzlampe 12V/H3 55W			091 312 002

Plus Serie Motor

Beschreibung

Referenz

Bestellnummer

Preis €

Motorblock



3 Zylinder
4 Zylinder

308 0001 0047
408 0001 0062

N30800010047
N0001

Kernlochdeckel



Ø 17 mm
Ø 20 mm
Ø 26 mm
Ø 30 mm

900 0398 4080
900 0398 9282
900 0398 1904
900 0398 9294

N0010
N0151
N0152
N0002

Kurbelwelle

308 0002 0028

500 022 306



passend für:
WD306 Motor

Kurbelwelle

406 02 0012

500 022 406



passend für:
WD406 Motor

Kurbelwellensimmering

500 122 003

vorne

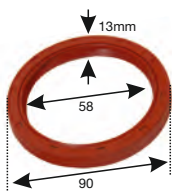

passend für:
30/430 WD209

Kurbelwellensimmering

500 122 004

hinten

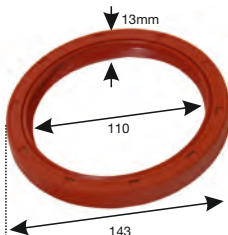

passend für:
30/430 WD209

Plus Serie Motor

Beschreibung	Referenz	Bestellnummer	Preis €
 <p>Kurbelwellensimmering vorne</p> <p>passend für: WD306/307/308 WD406/407/408</p>		500 122 001	
 <p>Kurbelwellensimmering hinten</p> <p>passend für: WD306/307/308 WD406/407/408</p>		500 122 002	
 <p>Anlaufscheiben-Satz für Kurbelwelle</p> <p>passend für: 30/430 WD209</p>		500 122 107	
<p>Anlaufscheiben-Satz für Kurbelwelle</p> <p>passend für: WD306/307/308 WD406/407/408</p>		500 122 108	
 <p>Zylinderbüchse (Götze)</p> <p>passend für: WD308/408</p>	408 00 04 0032	N0040	
 <p>Kolben (NÜRAL Germany) inkl. Bolzen, Sicherungsringe und Kolbenringe</p> <p>passend für: WD308/408</p>	408 00 03 0707	N0142	
 <p>Büchsenring</p> <p>passend für: WD307/308/407/408</p>	311 00 04 0016	N0041	

Plus Serie Motor

Beschreibung

Referenz

Bestellnummer

Preis €



Symbolfoto

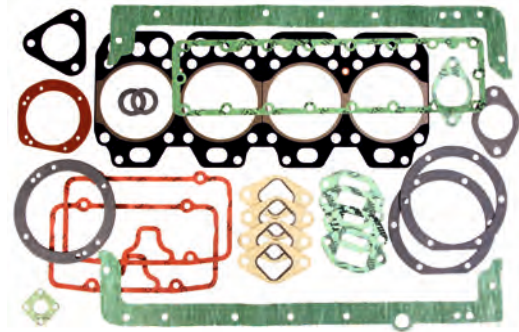

Symbolfoto



Symbolfoto



Symbolfoto

Motor Rep-Statz

3 Zylinder WD307

passend für:
40, 540

mit Ø 98 mm Bohrung

Set bestehend aus:

Kolben/Büchsen/Satz	3 x N0142-KT90
Pleuellagersatz	1 x N0137
Entrußersatz	1 x 500 118 003
Kopfdichtung	1 x 500 121 002

Motor Rep-Statz

4 Zylinder WD407

passend für:
50, 650

mit Ø 98 mm Bohrung

Set bestehend aus:

Kolben/Büchsen/Satz	4 x N0142-KT90
Pleuellagersatz	1 x N0137
Entrußersatz	1 x 500 118 004
Kopfdichtung	1 x 500 121 004

Motor Rep-Statz

3 Zylinder WD308

passend für:
40, 540, 545, 548

mit Ø 100 mm Bohrung

Set bestehend aus:

Kolben/Büchsen/Satz	3 x N0142-KT68
Büchsenringe	6 x N0041
Pleuellagersatz	1 x N0137
Kopfdichtsatz	1 x 500 121 910

Motor Rep-Statz

4 Zylinder WD408

passend für:
50, 650, 658
60, 760, 768

mit Ø 100 mm Bohrung

Set bestehend aus:

Kolben/Büchsen/Satz	4 x N0142-KT68
Büchsenringe	8 x N0041
Pleuellagersatz	1 x N0137
Kopfdichtsatz	1 x 500 121 920

Plus Serie Motor

Beschreibung	Referenz	Bestellnummer	Preis €
--------------	----------	---------------	---------



Kolben „Normalverfahren“
 passend für:
Plus 30/430 Motor WD210
870 Motor WD410
Motor WD611

Standard Ø 105 mm
 1. Rep.- Stufe Ø 105,5 mm

500 021 015
 500 021 016

Kolben „Listerverfahren“
 passend für:
Plus 30/430 Motor WD210



Standard Ø 105 mm
 1. Rep.- Stufe Ø 105,5 mm
 2. Rep.- Stufe Ø 106 mm

500 021 018
 500 021 019
 500 021 020

Kolbenringsatz

passend für:
Plus 30/430 Motor WD210



Standard Ø 105 mm
 1. Rep.- Stufe Ø 105,5 mm
 2. Rep.- Stufe Ø 106 mm

500 221 003
 500 221 006
 500 221 007

Kolben / Büchsen / Ring-Satz

(NÜRAL Germany, GÖTZE)
 Ø 98 mm Bohrung

N0142-KT90



passend für:
 WD307/407

Kolbenring-Satz (Götze)

408 00 03 0005

500 221 004



passend für:
 WD307/407

Büchsenring

311 00 04 0016

N0041



passend für:
 WD307/407

Kolben / Büchsen / Ring-Satz

(NÜRAL Germany, GÖTZE)
 Ø 100 mm Bohrung

N0142-KT68







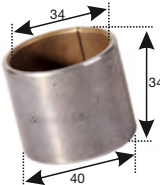

passend für:
 WD308/408

Plus Serie Motor

Beschreibung	Referenz	Bestellnummer	Preis €
	Kolbenring-Satz (Götze)	408 00 03 0005	N0149
passend für: WD308/408			
	Büchsenring	311 00 04 0016	N0041
passend für: WD308/408			
	Pleuellagerpaar WD209/WD210	1 Paar	N0137-1
Standard Übermaß 0,25 mm	1 Paar	N0139-2	
passend für: 30/430			
	Pleuellagersatz	1 Satz (4 Paar)	N0137
Standard	1 Satz (4 Paar)	N0138	
Übermaß 0,25 mm	1 Satz (4 Paar)	N0139	
Übermaß 0,50 mm	1 Satz (4 Paar)	N0140	
Übermaß 0,75 mm	1 Satz (4 Paar)		
passend für: 40, 50, 60, 540, 650, 760 545. 548. 658. 768. 980			
	Pleuellagerpaar WD409/410	1 Paar	N0137-1
Standard	1 Paar	N0139-2	
Übermaß 0,25 mm	1 Paar		
passend für: 70, 870, 980			
i Je Motor werden 4 Paar benötigt!			
Pleuellagersatz WD609/WD610	1 Paar	N0137-1	
Standard	1 Paar	N0139-2	
Übermaß 0,25 mm	1 Paar		
passend für: 1090, 1400			
i Je Motor werden 6 Paar benötigt!			

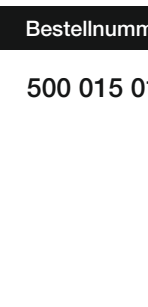
Plus Serie Motor

	Beschreibung	Referenz	Bestellnummer	Preis €
	<p>Pleuelbuchse</p> <p>passend für: Plus Serie</p>	407 03 0011	500 015 011	
	<p>Pleuelstange</p> <p>passend für: Plus Serie</p>	407 03 0607	500 015 001	
	<p>Pleuelschraube</p> <p>passend für: 30/430</p>		500 015 002	
	<p>Pleuelschraubenmutter</p> <p>passend für: 30/430</p>		500 015 003	
	<p>Pleuelschraube</p> <p>passend für: Plus Serie</p>	406 U03 0002	N0141	
	<p>Hauptlager Paar</p> <p>Standard Übermaß 0,25 mm</p> <p>passend für: 30/430</p>	<p>i Je Motor werden 3 Paar benötigt!</p>	<p>500 016 003 500 016 203</p>	
	<p>Hauptlagersatz</p> <p>Standard Übermaß 0,25 mm Übermaß 0,50 mm Übermaß 0,75 mm Übermaß 1,00 mm</p> <p>passend für: Plus Serie</p>	<p>1 Satz (5 Paar) 1 Satz (5 Paar) 1 Satz (5 Paar) 1 Satz (5 Paar) 1 Satz (5 Paar)</p>	<p>N0017 N0018 N0019 N0020 N0021</p>	

Plus Serie Motor

Beschreibung	Referenz	Bestellnummer	Preis €
 <p>Hauptlager Paar standard Hauptlager Paar 1. Übermaß 0,25mm</p> <p>passend für: 70, 870, 980 WD409/410</p>		500 016 003	
		500 016 203	
 Je Motor werden 5 Paar benötigt!			
<p>Hauptlager Paar standard Hauptlager Paar 1. Übermaß 0,25mm</p> <p>passend für: Plus 1090,1400 WD609/610</p>		500 016 003	
		500 016 203	
 Je Motor werden 7 Paar benötigt!			
 <p>Hauptlagerbock</p> <p>passend für: Plus Serie</p>	406 01 0006	N0009	
 <p>Zylinderkopf für M14 Schrauben ohne Ventile</p> <p>passend für: 658, 760, 768</p>	411 00 04 0003	520 020 900	
	411 00 04 0004		
	411 00 04 0015		
	1411 00 04 0004		
	1411 00 04 0015		
<p>Zylinderkopf komplett für M14 Schrauben mit Federn und Ventile</p> <p>passend für: 658, 760, 768 (WD308)</p>	411 00 04 0003	520 020 901	
	411 00 04 0004		
	411 00 04 0015		
	1411 00 04 0004		
	1411 00 04 0015		
 <p>Zylinderkopf komplett für M14 Schrauben mit Federn und Ventile</p> <p>passend für: 548 (WD308)</p>	1311 00 04 0003	520 020 902	
	1311 00 04 0023		
	1307 040601		
	308 00 04 0015		
	1308 00 04 0014		
 <p>Zylinderkopfschraube M12</p> <p>passend für: 40, 50, 60, 540, 650 ,760</p>	406 U03 0002	N0159-1	

Plus Serie Motor

Beschreibung

Referenz

Bestellnummer

Preis €

Zylinderkopfschraube
M14

311 00 04 0017

N0159

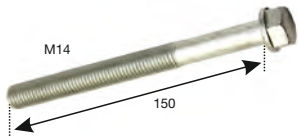

passend für:
548, 658, 768

Einlassventil

500 014 001

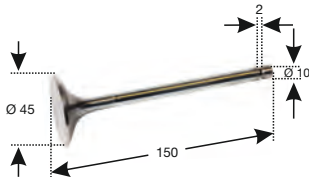

passend für:
Plus 30/430
870, 980, 1090, 1100

Auslassventil

500 014 002

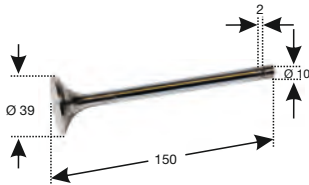

passend für:
Plus 30/430
870, 980, 1090, 1100

Einlassventil

407 0005 01
1407 0005 01

500 014 003

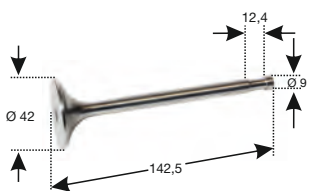

breite Nut
passend für:
40, 540, 545, 50, 650
60, 760

Auslassventil

407 0005 02
1407 00 05 02

500 014 004

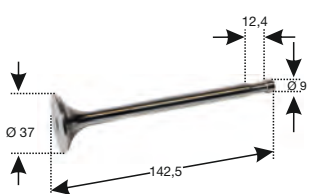

breite Nut
passend für:
40, 540, 545, 50, 650
60, 760

Einlassventil
schmale Nut

311 00 05 0014

500 014 005



passend für:
548, 568, 768

Auslassventil
schmale Nut



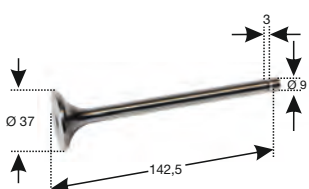

311 00 05 0015

500 014 006



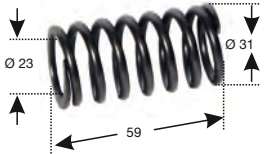

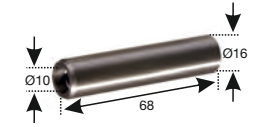

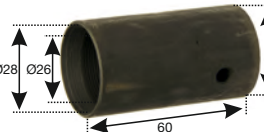
passend für:
548, 568, 768



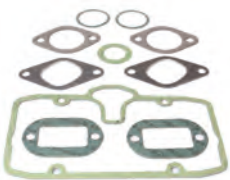
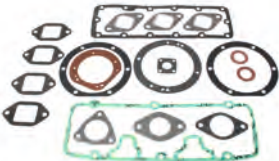
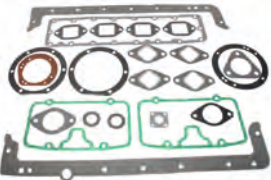

Plus Serie Motor

	Beschreibung	Referenz	Bestellnummer	Preis €
	Ventilfeder passend für: Plus Serie	406 05 0036	500 099 002	
	Ventileinstellschraube passend für: Plus Serie	405 05 0024	500 099 001	
	Ventilführung lang für Einlassventil passend für: Plus 30/430 870, 980, 1090, 1100		500 114 003	
	Ventilführung kurz für Auslassventil passend für: Plus 30/430 870, 980, 1090, 1100		500 114 004	
	Ventilführung lang für Einlassventil passend für: Plus Serie	311 0004 0029	500 114 005	
	Ventilführung kurz für Auslassventil passend für: Plus Serie	406 04 0603	500 114 006	
	Stößel passend für: Plus Serie	609 05 0002	500 114 001	

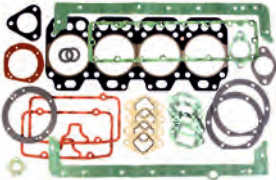

Plus Serie Motor

Beschreibung	Referenz	Bestellnummer	Preis €
	Entrußer-Satz 2 Zylinder	500 118 030	
passend für: Plus 30/430			
	Entrußer-Satz 3 Zylinder	500 118 003	
passend für: 40, 540, 545, 548			
	Entrußer-Satz 4 Zylinder	500 118 004	
passend für: 50, 650, 658 60, 760, 768			
	Zylinderkopfdichtung	207 04 007	500 121 007
passend für: 30/430			
	Zylinderkopfdichtung Ø 98 mm Bohrung	500 121 002	
passend für: WD307			
	Zylinderkopfdichtung Ø 100 mm Bohrung	500 121 006	
passend für: WD308			
	Zylinderkopfdichtung Ø 98 mm Bohrung	406 U04 0024	500 121 004
passend für: WD407			

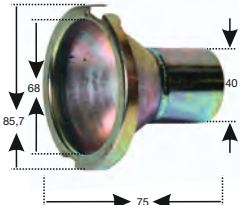
Plus Serie Motor

Beschreibung	Referenz	Bestellnummer	Preis €
	Zylinderkopfdichtung Ø 100 mm Bohrung	411 00 04 0039	500 121 008
passend für: WD408			
	Kopfdichtungssatz Ø 100 mm Bohrung		
3 Zylinder 4 Zylinder			
			500 121 910 500 121 920
	Motordichtssatz mit Entrußersatz ohne Kopfdichtung		
passend für :			
500 117 002	40/540/545/548	WD307 WD308	500 117 002
	50/650/658 mit Ölwanndichtung	WD407.40	bis Motor Nr.: 4685
500 117 003			500 117 003
	50/650/658 60/760/768	WD407.40 WD408.40	ab Motor Nr.: 4686
500 117 004			500 117 004
	Ölpumpe	406 A 07 0601	500 218 601
passend für: Plus Serie/288			
	ÖlfILTER	409 07 0036	N0235
passend für: Plus Serie/288			
	Öleinfüllstutzen	1313T010008 313T010008	500 018 001
passend für: Plus Serie			

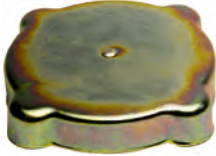
Plus Serie Motor

	Beschreibung	Referenz	Bestellnummer	Preis €
	Öldeckel	313 T01 0036	N0165	
	▶ Öldeckeldichtung passend für: Plus Serie	313 T01 0001	N0166	
<hr/>				
	Ölmesstab	406 01 0606	N0095	
	passend für: Plus Serie			
<hr/>				
	Zahnkranz			
	3 Zylinder (auch bei Plus 30) 4 Zylinder passend für: Plus Serie	2209 0002 0034 610 00 02 0021	520 006 013 526 006 014	

Plus Serie Diesel

Beschreibung

Referenz





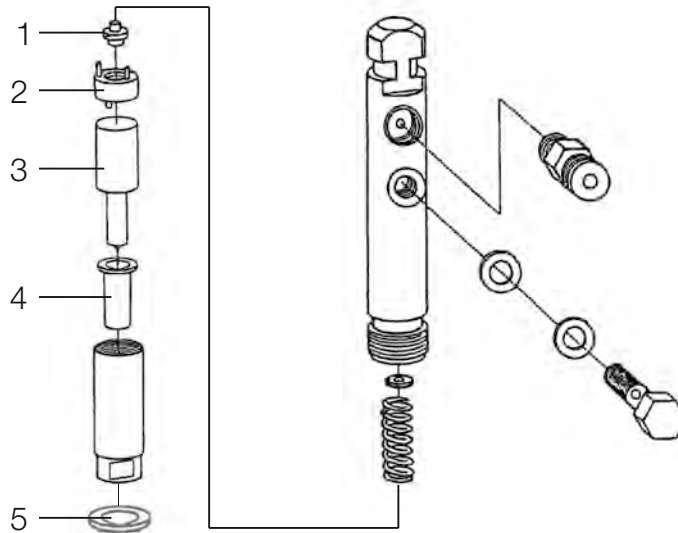



Bestellnummer

Preis €



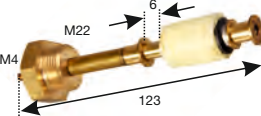

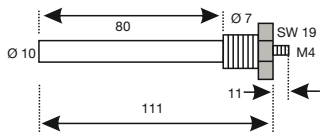

Beschreibung	Referenz	Bestellnummer	Preis €
1 Federteller	311 00 08 0703 9 432 360 800	135 620 800	
2 Zwischenstück	311 00 08 0701 9 432 360 080	135 630 080	
3 Einspritzdüse			
D1LMK150/24	409 00 08 0072 DLLA150S427 0 433 271 205	038 326 205	
passend für: 30/430, 870, 980, 988, 1090 1100, 1108, 1200			
D1LMK92/1 - D1LMK92/2	DLL50S226 0 433 220 066	038 275 066	
passend für: 30/430 mit WD210 Motor Listerverfahren			
D1LMK150/21	140 70 81 504 DLLA150S396 0 433 271 164	038 326 164	
passend für: 40, 540, 545, 50, 650, 60, 760			
D1LMK150/39	308 00 08 0046 DLLA150S891 0 433 271 440	038 326 440	
passend für: 548, 658, 768			
4 Wärmeschutzhülse		135 182 004	
5 Kupferscheibe			
Ø 11 x Ø 19 x 1,0 mm		135 751 119	
Ø 11 x Ø 19 x 1,5 mm		135 751 115	



Plus Serie Diesel

	Beschreibung	Referenz	Bestellnummer	Preis €
	Dieselfilter passend für: Plus Serie	407 08 0074	N0530	
	Filtergehäuse Kraftstofffilter passend für: Plus Serie	407 08 0122	501 290 001	
	Förderpumpe passend für: 1400	FP/KE22AD254/2	041 158 176	
	Tank passend für: 650, 658, 760, 768	292 55 0133	N0538	
	Tankgeber nur für Tank N0538	292 55 0132	N0553	
	Tankgeber für Originaltank passend für: Plus Serie	188 55 70	523 101 007	
	Tanksieb PVC Metall passend für: Plus Serie	188 55 0067	N0539 16060-35-009	

Plus Serie Diesel

	Beschreibung	Referenz	Bestellnummer	Preis €
	<p>Tankdeckel</p> <p>sperrbar nicht sperrbar</p> <p>passend für: Plus Serie</p>	192 55 151	21060-SV-904 04060-00-008	
	<p>Kraftstoffhahn</p> <p>passend für: Plus Serie</p>	1280 55 0068	N0551	
	<p>Wanne unter Kraftstofftank</p> <p>► Dichtung</p> <p>passend für: Plus Serie</p>	292 55 0109 292 55 0125	523 100 109 523 100 125	
	<p>Spannsatz für Stahlband</p> <p>passend für: Plus Serie</p>	292 55 0034	523 101 034	
	<p>Stahlband für Tankbefestigung</p> <p>passend für: Plus Serie</p>	280 55 0027 280 55 0028 280 55 029	523 101 028	

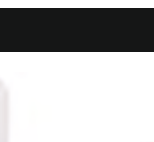

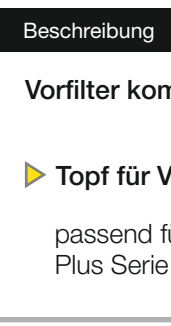
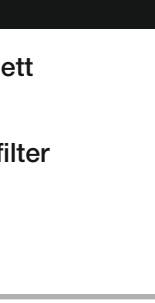



Plus Serie Filterteile

	Beschreibung	Referenz	Bestellnummer	Preis €
	Vorfilter komplett	407 11 0006	N0675	
	Topf für Vorfilter passend für: Plus Serie	307 19 0702	N0676	
	Trichter im Luftfiltertopf passend für: Plus Serie	280 19 0711	501 190 001	
	Profiling für Ölbadfilter passend für: 40/540/545/548 teilweise: 50/650/658	1406 19704	501 190 004	

Plus Serie Kühlung

	Beschreibung	Referenz	Bestellnummer	Preis €
	Wasserpumpe passend für: 30, 430	1209 060604	500 012 011	
	Wasserpumpe Riemenscheiben Ø 136 mm passend für: Plus Serie alte Ausführung	407 0006 0031 1407 0006 0031	500 012 004	
	Wasserpumpe mit Deckel und Dichtung passend für: 40, 540, 50, 650, 60. 760	308 00 06 0005	500 012 241	
	O-Ring bei Schaufelrad für Wasserpumpe 500 012 241 passend für: Plus Serie	406 06 0011	500 013 003	
	Wellendichtring bei Welle für Wasserpumpe 500 012 241 passend für: Plus Serie		N0262	
	Deckel für Wasserpumpe 500 012 241 passend für: Plus Serie	407 06 0021	N0267	
	Wasserrohr für Wasserpumpe 500 012 241 Ø 38 mm, Länge 45 mm Ø 22 mm, Länge 45 mm Ø 25 mm, Länge 16,5 mm	406 03 0023 406 06 0008 406 06 0004	N0253 N0254 N0255	

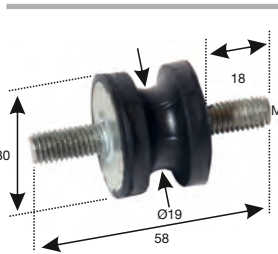
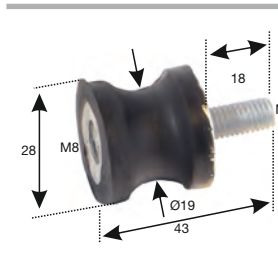





Plus Serie Kühlung

	Beschreibung	Referenz	Bestellnummer	Preis €
	Rep Satz mit Schaufelrad für Wasserpumpe 500 012 241 passend für: Plus Serie		N0241-6	
	Rep Satz mit Schaufelrad für Wasserpumpe 500 012 241 passend für: Plus Serie		N0241-5	
	Kühler passend für: 30, 430	1188 53 0027 1188 53 0031	500 011 188	
	Kühler mit Verschlussdeckel ▶ Kühlerverschluss	292 53 0014 380 953 0050	500 011 020 N0272	
	Gummilager für Kühler passend für: Plus Serie	188 54 0117	500 019 001	
	Gummilager für Kühler passend für: Plus Serie	273 92 0024 337 0053 0112	500 019 002	
	Kühlerschlauch passend für: Plus Serie	192 53 0012	N0297	



Plus Serie Kühlung

	Beschreibung	Referenz	Bestellnummer	Preis €
 <p>Technical drawing of a thermostat with dimensions: $\varnothing 38$ (height), $\varnothing 22$ (width).</p>	Thermostat passend für: Plus Serie	192 53 0034	N0293	
 <p>Technical drawing of a fan blade with dimensions: $\varnothing 145$ (height), $\varnothing 400$ (width), $\varnothing 30$ (inner diameter).</p>	Windflügel passend für: Plus Serie	408 0006 0032	N0245	



Plus Serie Auspuff

Beschreibung	Referenz	Bestellnummer	Preis €
 <p>M10 78 M8 65</p>	<p>Auspuffkrümmer für 3-Zylinder</p> <p>passend für: 40, 540, 545, 548</p>	<p>307 11 0601 307 11 0004 1307 11 0601 1307 11 0004</p>	<p>526 200 006</p>
	<p>Auspuffkrümmer für 4 Zylinder</p> <p>passend für: 50, 650, 658, 60, 760, 768</p>	<p>407 11 0007</p>	<p>526 200 004</p>
	<p>Anschlusskrümmer 3 Zylinder</p> <p>passend für: 40, 540, 545, 548</p>	<p>307 11 0008</p>	<p>526 200 003</p>
	<p>Anschlusskrümmer 4 Zylinder</p> <p>passend für: 50, 650, 658, 60, 760 ,768</p>	<p>407 11 0024</p>	<p>N0638</p>
	<p>Krümmerdichtung zu Zylinderkopf</p> <p>passend für: Plus Serie</p>	<p>408 001 0009</p>	<p>N0635</p>
	<p>Dichtung zwischen Auspuff- und Anschlusskrümmer</p> <p>passend für: Plus Serie</p>	<p>288 54 0018</p>	<p>N0639</p>

Plus Serie Auspuff/Kupplung

Beschreibung	Referenz	Bestellnummer	Preis €
 <p>Auspufftopf passend für: Plus Serie</p>	192 54 0091	N0641	
 <p>Auspuffklappe passend für: Plus Serie</p>	192 54 0051	N0642	
 <p>Auspuffdichtung 3 Loch passend für: Plus Serie</p>	407 11 0021	N0643	







Kupplung

 <p>Druckplatte Neu mit 3 Hebel ohne Kupplungsscheibe Ø 280 mm</p>	406 160 901	520 002 003	
 <p>Druckplatte Sachs Tausch passend für: 40 WD307 540/a WD307.40</p>		520 002 001 Kaution	
 <p>Druckplatte Neu mit Stern passend für: 540/a WD308.40 545/a WD308.41 548/a WD308.45 650/a WD408.41 658/a WD408.42</p>	407 160 902	520 002 004	<p>i Für Modelle, die als Zapfwellenkupplung eine Lamellenkupplung haben!</p>

Plus Serie Kupplung

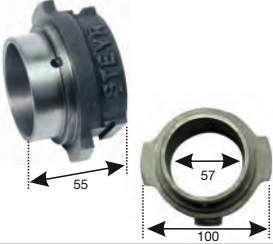
Beschreibung	Referenz	Bestellnummer	Preis €
	Druckplatte Sachs Tausch mit 3 Hebel ohne Kupplungsscheibe Ø 310 mm		520 002 005 Kaution
	passend für: 760,a WD408.40 768,a WD408.43		
	Kupplungsscheibe Sachs Ø 225mm 10 Zähne		520 001 188
	passend für: Plus 30/ 430 WD210.40		
	Kupplungsscheibe starr Ø 280mm, 10 Zähne 28/35	308 0016 0001	520 001 180
	passend für: 540/545/548/650/658/760		
	Kupplungsscheibe gefedert Ø 280mm,		520 001 181
	passend für: 540/545/548/650/658/760		
	Kupplungsscheibe Sachs Tausch Ø 310 mm, 10 Zähne 28/35	408 0016 0905 1408 0016 0905	520 001 002 Kaution
	Kupplungsscheibe Ø 310 mm, 10 Zähne 28/35		520 001 003
	passend für: 760,a WD408.40 768,a WD408.43		
	Drucklager	337 0021 00 20 1337 0021 00 20	520 003 001
	passend für: 40/540/548 50/650/658 60/760/768		
	Kupplungsfeder	119 223 0064	N1053-1
	passend für: Plus Serie		

Plus Serie Kupplung

	Beschreibung	Referenz	Bestellnummer	Preis €
	<p>Konsole</p> <p>passend für: Plus Serie</p>	292 23 0056	N1164	
	<p>Kupplungswelle</p> <p>passend für: Plus Serie</p>	292 23 0048	N1181	
	<p>Gabel</p> <p>passend für: Plus Serie</p>	292 27 0044	N1187	
	<p>Kupplungsausrückmuffe ohne Kugellager</p> <p>passend für: Plus Serie</p>	292 27 0086 292 27 0081	520 004 086	
	<p>Drucklager zu Kupplungsausrückmuffe</p> <p>passend für: Plus Serie</p>	900 0331 5494	N1200	
	<p>Flansch bei Lamellenkupplungsbetätigung</p> <p>passend für: Plus Serie</p>	292 27 0038	N1195	
	<p>Welle</p> <p>passend für: Plus Serie</p>	292 27 0041	520 004 041	

Plus Serie Kupplung/Getriebe

Beschreibung	Referenz	Bestellnummer	Preis €
 <p>Kupplungshandhebel für Doppel-Trocken-Kupplung und Lamellenkupplung</p> <p>passend für: 540, 545, 650, 658, 760, 768</p>	292 27 099 288 0024 0030	520 004 020	
 <p>Sperrklinke für Kupplungshandhebel 520 004 020/023</p> <p>passend für: 540, 545, 650, 658, 760, 768</p>	390 35 0055	N1210	
 <p>Segment</p> <p>passend für: Plus Serie</p>	337 0027 0242 1 337 0027 2143 1 337 0027 0352 1 337 0027 0458	520 004 021	

Getriebe

 <p>Antriebswelle</p> <p>passend für: 650, 760 658, 768 bei schrägverzahntem Getriebe</p>	292 22 0057 1292 22 0057	520 006 005	
 <p>Hauptwelle</p> <p>passend für: Plus Serie</p>	292 220261 1292 220261	520 006 261	
 <p>Kugellager</p> <p>passend für: Plus Serie</p>	292 22 0133	520 006 133	

Plus Serie

Getriebe/Zapfwellenkupplung

Beschreibung

Referenz

Bestellnummer

Preis €

Hohlwelle

292 270033
1292 270033

520 006 008

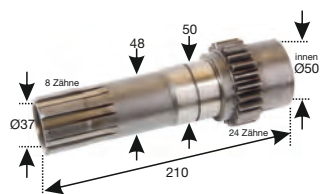

passend für:
650, 658, 760, 768
bei schrägverzahntem
Getriebe

Nadellager innen

zu Hohlwelle 520 006 008

292 270034
1292 270034

520 006 034



passend für:
650, 658, 760, 768
bei schrägverzahntem
Getriebe

Kupplungsglocke

für Zapfwellenkupplung Ø 130 mm

292 27 0094
1292 27 0094

520 006 007



passend für:
650, 658, 760, 768
bei schrägverzahntem
Getriebe

Lamelle

für Zapfwellenkupplung

188 22 0017

520 004 051

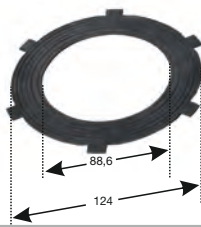

passend für:
430, 540, 545, 650

Lamelle

für Zapfwellenkupplung

188 22 0016

520 004 052

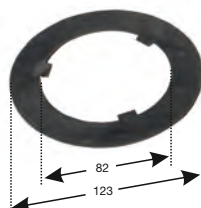

passend für:
430, 540, 545, 650

Lamelle

für Zapfwellenkupplung

288 22 0016

520 004 016

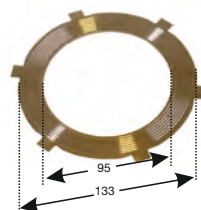

passend für:
650, 760, 768

Lamelle

für Zapfwellenkupplung

288 22 0017

520 004 017

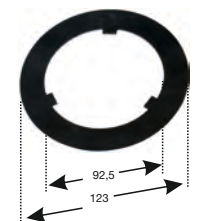

passend für:
650, 760, 768

Plus Serie Zapfwellenkupplung/Welle

Beschreibung	Referenz	Bestellnummer	Preis €
 <p>Höhe 9,6 70 109</p>	<p>Druckring für Zapfwellenkupplung</p>	192 27 0085	520 008 085
<p>passend für: Plus Serie 540/548 (Doppelkupplung)</p>			
 <p>Höhe 8,5 49 83</p>	<p>Druckring für Zapfwellenkupplung</p>	292 27 0132	520 006 010
<p>passend für: Plus Serie 760/768</p>			
 <p>Höhe 2,5 35 88</p>	<p>Federteller für Zapfwellenkupplung</p>	292 22 0098	520 004 055
<p>passend für: Plus Serie</p>			
 <p>18Z 8Z Ø20 25 137 205</p>	<p>Welle</p>	292 22 0129 1292 22 0129	520 006 009
<p>passend für: Plus Serie</p>			
 <p>Höhe 19 45 85</p>	<p>Druckring / Lager</p>	900 0332 1728 557 0022 0153	N1389
<p>passend für: Plus Serie</p>			
	<p>Platte für Zapfwellenkupplung</p>	295 27 0001	N1405
<p>passend für: Plus Serie</p>			
 <p>48 90 112</p>	<p>Ausrücker für Zapfwellenkupplung</p>	292 27 0015	N1406
<p>passend für: Plus Serie</p>			

Plus Serie Zapfwelle/Getriebesteuerung

Beschreibung	Referenz	Bestellnummer	Preis €
--------------	----------	---------------	---------



Zapfwellenschutz

288 27 0096

N1415

passend für:
Plus Serie

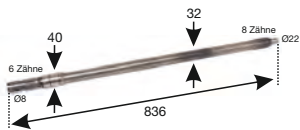

Zapfwelle

295 270002
1295 270002

520 007 002

passend für:
760

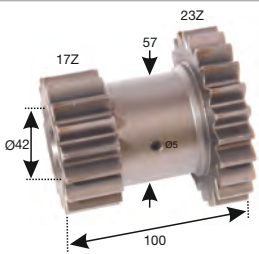

Doppelzahnrad

292 27 0026
1292 27 0026

520 007 026

passend für:
760

Getriebesteuerung



Schaltdeckel bei Getriebe
für Schalthebel

190 24 0005
1190 24 0005

N1647

passend für:
Plus Serie



Gummimanschette
für Schalthebel

290 24 0012
1290 24 0012

N1656

passend für:
Plus Serie



Handgashebel

3905700040

523 100 005

passend für:
Plus Serie

Plus Serie

Hinterachse/Antrieb

	Beschreibung	Referenz	Bestellnummer	Preis €
	<p>Bremsplatte</p> <p>passend für: Plus Serie</p>	<p>317 0033 0007 1317 0033 0007</p>	<p>524 214 001</p>	
	<p>Hinterachswelle</p> <p>passend für: Plus Serie</p>	<p>317 003 20015 1 317 003 20015</p>	<p>522 100 009</p>	
	<p>Achsgehäuse</p> <p>passend für: Plus Serie</p>	<p>290 33 0001 1290 33 0001</p>	<p>N1832</p>	
	<p>Tellerrad und Ritzel</p> <p>passend für: 650, 658, 760, 768 mit schräg verzahntem Getriebe</p>	<p>292 32 0602 1292 32 0602</p>	<p>522 100 602</p>	
	<p>Ring</p> <p>passend für: Plus Serie</p>	<p>292 32 0003 1292 32 0003</p>	<p>N1868</p>	
	<p>Nadellager</p> <p>passend für: Plus Serie</p>	<p>188 29 0046 1188 29 0046</p>	<p>N1875</p>	
	<p>Scheibe</p> <p>passend für: Plus Serie</p>	<p>290 32 0003 1290 32 0003</p>	<p>N1876</p>	

Plus Serie Antrieb/Bremse

Beschreibung	Referenz	Bestellnummer	Preis €
--------------	----------	---------------	---------

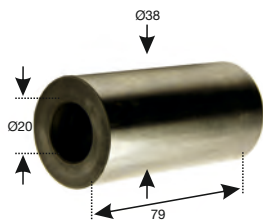

Bolzen

290 32 0001
1290 32 0001

N1877

passend für:
Plus Serie

Bremse



Bremsbelag hinten

1 92 34 1001
92 34 0007

524 212 002

passend für:
Plus Serie 30/430

► **Niete** 4 x 10 mm (VPE 100 Stk)

190003913524

524 219 001

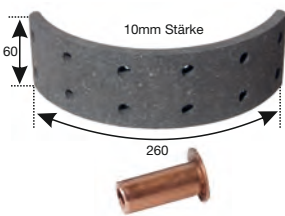

Bremsbelag hinten

192 34 0020
1192 34 1001

524 212 007

passend für:
40, 540/a, 545/a, 548/a

► **Niete** 4 x 12 mm (VPE 100 Stk)

190003913561

524 219 002

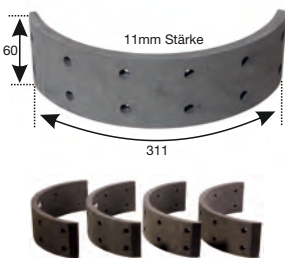

Bremsbelag Satz (4 Stk) hinten

192 34 0020
1192 34 1001

524 212 006

passend für:
50, 650/a, 658, 760, 768

i ACHTUNG:
Bestelleinheit ist 1 Satz mit
4 Stück!

► **Niete** 4 x 16 mm (VPE 1 KG)

900 0391 3561

524 219 003



Bremsbelag Feststellbremse

1 92 34 1001
92 34 0007

524 212 002

passend für:
540, 545, 545a, 650, 658, 760, 768

► **Niete** 4 x 10 mm (VPE 100 Stk)

190003913524

524 219 001



Plus Serie Bremse

	Beschreibung	Referenz	Bestellnummer	Preis €
	Bremsbelag hinten passend für: 658a, 760a, 768a	295 34 0011	524 212 004	
	Niete 4 x 10 mm (VPE 100 Stk)	190003913524	524 219 001	
	Radbremszylinder vorne Originalqualität passend für: 540, 545, 650, 658, 760, 768	190 34 0863 1190 34 0863	524 215 001	
	Radbremszylinder hinten ohne Nachstellung passend für: 540, 545, 650, 760, bis Fgst. Nr 2584 658, 768	295 34 0601 1295 34 0601 295 34 0012 1295 34 0012	524 215 501	
	Brems Schlauch M12 x 1 450 mm passend für: Plus Serie	90003559720 190003559720 1-34-735-001	524 213 001	
	Brems Schlauch M12 x 1 320 mm passend für: Plus Serie	90003559721 190003559721	524 213 002	
	Büchse für Bremswelle bei Bremstrommel passend für: Plus Serie	295 34 0026 1295 34 0026	N1895	
	Handbremssegment passend für: Plus Serie	288 35 0120 1288 35 0120	N1921	

Plus Serie Bremse

	Beschreibung	Referenz	Bestellnummer	Preis €
	<p>Handbremshebel nicht bei unabhängiger Feststellbremse</p> <p>passend für: 650 ab Fgst. Nr.: 6559 658, 760, 768</p>	<p>292 35 0053 1292 35 0053</p>	<p>524 900 053</p>	
	<p>Bolzen für Handsegment N1921 Feststellbremse</p> <p>passend für: Plus Serie</p>	<p>288 35 0016 1288 35 0016</p>	<p>N1928</p>	
	<p>Sperrklinke</p> <p>passend für: 540, 545, 650, 658, 760, 768</p>	<p>292 27 0099</p>	<p>N1210</p>	
	<p>Rückzugsfeder für Bremswelle bei Bremstrommel</p> <p>passend für: Plus Serie</p>	<p>288 35 0093 1288 35 0093</p>	<p>N2000</p>	
	<p>Feder bei Bremsbacken</p> <p>passend für: Plus Serie</p>	<p>288 34 0042 1288 34 0042</p>	<p>N2008</p>	
	<p>Bremspedalrückzugsfeder für Hydraulik Bremse</p> <p>passend für: 870a ab Fgst-Nr. 2400/186 980, 988, 1090, 1100, 1108, 1200,a</p>	<p>1180A 340026</p>	<p>524 214 005</p>	
	<p>Bremstrommel</p> <p>passend für: Plus Serie</p>	<p>290 34 0007 1290 34 0007</p>	<p>N2011</p>	

Plus Serie Lenkung

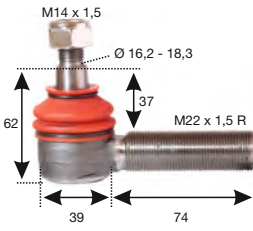
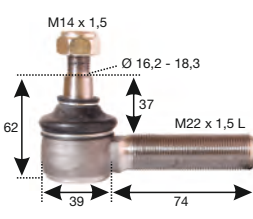
	Beschreibung	Referenz	Bestellnummer	Preis €
	<p>Lenkrad</p> <p>passend für: Plus Serie</p>	92 47 0018	N2075	
	<p>Abdeckkappe für N2075</p> <p>passend für: Plus Serie</p>	92 47 0003	N92470003	
	<p>Lenkgehäuse</p> <p>passend für: Plus Serie</p>	295 47 0004 1295 47 0004	N2079	
	<p>Kugelgelenk M22 x 1,5 R 16,2 -18,3</p> <p>passend für: 30, 430, 40, 540, 545, 548 50, 650 , 658, 760, 768</p>	1192 43 0735 1192 43 0087 1292 430 721 1190 430 700	522 300 735	
	<p>Kugelgelenk M22 x 1,5 L 16,2 -18,3</p> <p>passend für: 30, 430, 40, 540, 545, 548 50, 650 , 658, 760, 768</p>	1192 43 0741 1292 43 0721 1292 43 0087	522 300 741	

Plus Serie Achse

Beschreibung

Referenz

Bestellnummer

Preis €

Vorderachsbock

317 0041 001
1317 0041 001

522 100 012



passend für:
Plus Serie

Mittelachsbolzen

192 41 0011
1192 41 0011

N2236

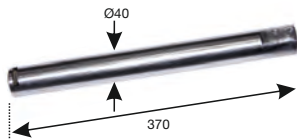

passend für:
Plus Serie

Buchse
für Mittelachsbolzen

192 41 0137
1192 41 0137

N2218

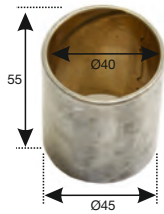

passend für:
Plus Serie

Anlaufscheibe

192 41 0037
1192 41 0037

N2250

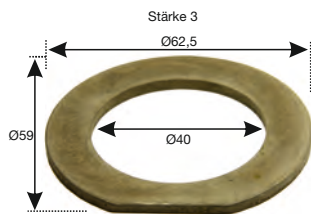

passend für:
Plus Serie

Anlaufscheibe

192 41 0038
1192 41 0038

N2251

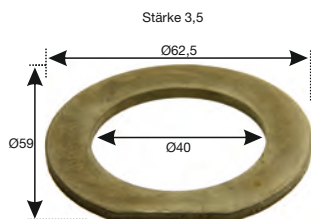

passend für:
Plus Serie

Anlaufscheibe

192 41 0039
1192 41 0039

N2252

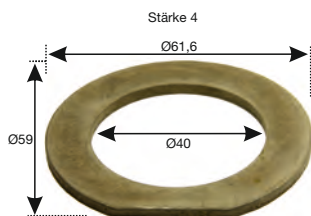

passend für:
Plus Serie

Lenkhebel



292 41 0068
1292 41 0068

N2264



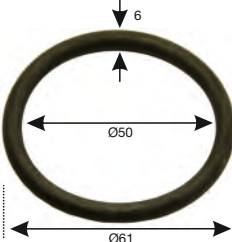

passend für:
Plus Serie

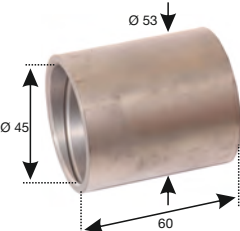
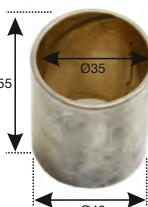
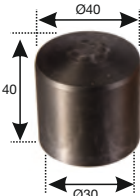
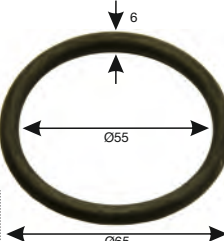
Plus Serie Achse

Beschreibung	Referenz	Bestellnummer	Preis €
 <p>Stiftschraube für Lenkhebel</p> <p>passend für: Plus Serie</p>	900 388 8624	N2268	
 <p>O-Ring für Lenkhebel</p> <p>passend für: Plus Serie</p>	180 41 0049 1180 41 0049	N2262	
 <p>Keilbolzen für Lenkhebel</p> <p>passend für: Plus Serie</p>	280 41 0027 1280 41 0027	N2266	
 <p>Lagerbuchse für Lenkhebel</p> <p>passend für: Plus Serie 870/980</p>	390 41 0018	522 100 006	
 <p>Lagerbuchse für Achsschenkel und Lenkhebel</p> <p>passend für: Plus Serie</p>	192 41 0138 1192 41 0138	N2257	
 <p>Achsschenkelbuchse Stahl</p> <p>passend für: 40, 540 (Allrad geschossen)</p>	292 41 0140 1292 41 0140	522 100 140	
 <p>O-Ring für Achsschenkel</p> <p>passend für: Plus Serie</p>	192 41 0041 1192 41 0041	N2263	

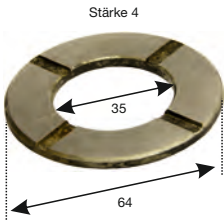
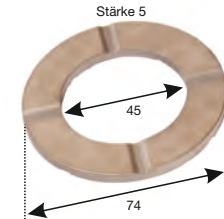
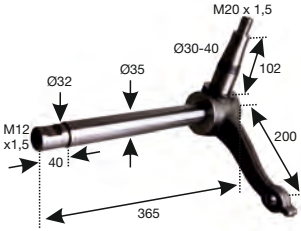
Plus Serie Achse

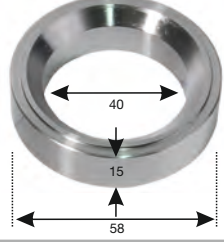
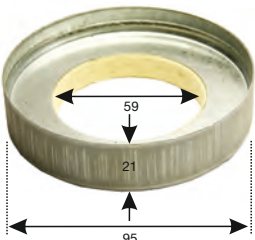





Beschreibung	Referenz	Bestellnummer	Preis €
 <p>Stärke 4</p>	<p>Reibscheibe für Achsschenkel</p>	<p>288 41 0205 1288 41 205</p>	<p>N2261</p>
 <p>Stärke 5</p>	<p>Reibscheibe für Achsschenkel</p>	<p>390 41 0025</p>	<p>522 100 007</p>
	<p>Achsschenkel Rechts Links</p> <p>passend für: 50, 650 , 658, 60, 760, 768, 40, 540, 548 mit Radflansch 522 100 050</p>	<p>292 41 0078 1292 41 0078 1292 41 0778 292 41 0077 1292 41 0077 1 292 41 777</p>	<p>N2222 N2221</p>
	<p>Labyrinthblech</p> <p>passend für: Plus Serie</p>	<p>288 41 0146 1288 41 0146</p>	<p>N2276</p>
	<p>Anlaufring</p> <p>passend für: Plus Serie</p>	<p>288 41 0145 1288 41 0145</p>	<p>N2277</p>
	<p>Dichtungstopf</p> <p>passend für: Plus Serie</p>	<p>288 41 0147 1288 41 0147</p>	<p>N2282</p>

i Nicht für Frontlader geeignet!

Plus Serie Achse/Hydraulik

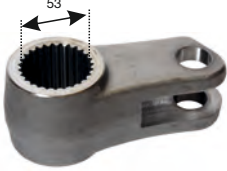
	Beschreibung	Referenz	Bestellnummer	Preis €
	Radflansch passend für: 40, 540, 545, 548, 50, 650, 658 60, 760, 768	288 41 0131 1288 41 0131	522 100 050	
Hydraulik				
	Hydraulikpumpe passend für: 540, 545, 548, 650, 658, 768	0 510 410 322 0 510 415 313 0 510 415 316	521 010 003	
	Hydraulikpumpe passend für: 430 ab Motor Nr 3988 40, 540, 545, 548	0 510 520 309 0 510 525 335 0 510 525 311 306A130004 306A130005	521 010 005	
	Hydraulikpumpe passend für: 650, 760, 870	0 510 625 315	521 010 002	
	Hydraulikpumpe passend für: 650, 658, 658a, 760, 768, 768a 870, 980a, 988, 1090, 1100, 1108, 1200, 1400	0 510 615 321 0 510 615 337	521 010 008	
	Hydraulikzylinder passend für: 50, 650, 658, 760, 768	288 73 0060 1288 73 0060	521 020 060	

Plus Serie Hydraulik

	Beschreibung	Referenz	Bestellnummer	Preis €
	<p>Manschette für Hydraulikzylinder</p> <p>passend für: 50, 650, 658, 760, 768</p>	<p>288 73 102 1288 73 102</p>	<p>521 020 102</p>	
	<p>Hydraulikkolben</p> <p>passend für: 50, 650, 658, 760, 768</p>	<p>288 73 0066</p>	<p>521 020 001</p>	
	<p>Anlenkblock</p> <p>passend für: Plus Serie</p>	<p>292 73 0051 1292 73 0051</p>	<p>522 200 051</p>	
	<p>Hydraulikhebel</p> <p>passend für: 40, 540, 545, 548</p>	<p>192 73 0022</p>	<p>521 020 002</p>	
	<p>Hydraulikhebel</p> <p>passend für: 50, 650, 658, 760, 768</p>	<p>288 73 0057</p>	<p>521 020 057</p>	
	<p>Feder für Oberlenker</p> <p>passend für: Plus Serie</p>	<p>390 73 0055 1390 73 0055</p>	<p>N2336</p>	
	<p>Hubgabel</p> <p>passend für: Plus Serie</p>	<p>292 74 0054 1292 74 0054</p>	<p>N2534</p>	

Plus Serie Hydraulik

Beschreibung	Referenz	Bestellnummer	Preis €
	Hubstrebe rechts verstellbar	295 74 0501 1295 74 0501	N2546
passend für: Plus Serie			
	Hubstrebe links	295 74 502 1295 74 502	N2549
passend für: Plus Serie			
	Gabelrohr	295 74 0001 1295 74 0001	N2550
passend für: Plus Serie			
	Gelenksstück	190 74 0196	522 200 011
passend für: teilweise Plus Serie			
	Gelenksstück	292 74 0078	522 200 010
passend für: teilweise Plus Serie			
	Bolzen	292 74 0142 1292 74 0142	N2620
passend für: Plus Serie			
	Seitenstrebe	395 74 0166 1395 74 0166	N2622 N2622-1
passend für: Plus Serie			

Plus Serie Hydraulik

	Beschreibung	Referenz	Bestellnummer	Preis €
	<p>Ackerschiene</p> <p>passend für: Plus Serie</p>	<p>337 00 74 0051 1337 00 74 0051</p>	<p>522 200 004</p>	
	<p>Endzusatz-Steuergerät</p> <p>passend für: Plus Serie</p>	<p>028 0073 0010</p>	<p>522 230 010</p>	
	<p>Zusatzsteuergerät</p> <p>passend für: Plus Serie</p>	<p>397 73 0174 1397 73 0174</p>	<p>522 201 174</p>	
	<p>Anhängbock</p> <p>passend für: Plus Serie</p>	<p>295 93 0007 1295 93 0007</p>	<p>N2836</p>	
	<p>Bolzen für Anhängvorrichtung</p> <p>passend für: teilweise Plus Serie</p>	<p>80 76 6192</p>	<p>N2845</p>	
	<p>Anhängevorrichtung</p> <p>passend für: Plus Serie</p>	<p>295 93 0003 1295 93 0003</p>	<p>N2846</p>	
	<p>Anhängernagel</p> <p>Länge 370 mm Länge 600 mm</p> <p>passend für: Plus Serie</p>	<p>295 93 0004</p>	<p>N2854 N2854-9</p>	

Plus Serie Karosserie

Beschreibung

Referenz

Bestellnummer

Preis €



Motorhaube

293 13 0130
1293 13 0130

523 100 009

passend für:
Plus Serie 4 Zylinder
50, 650 , 658, 60, 760 ,768

Haltefeder

für Haltestange des
Motorhaubendeckels

1293 130090

523 100 013

passend für:
Plus Serie



Feder

für Motorhauberverriegelung

680 33 508
1680 33 508

523 100 026

passend für:
Plus Serie

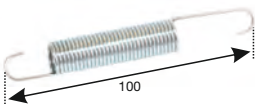

Scharnier

passend für:
Plus Serie

293 14 0146
1293 14 0146

523 100 006



Scharnier

passend für:
Plus Serie

293 13 0147
1293 13 0147

523 100 007



Plus Serie Karosserie

Beschreibung

Referenz

Bestellnummer

Preis €

Kühlergrill mit Scheinwerfer

N2919-1

zum Umbau auf H4 Scheinwerfer
(ohne Einbausatz)



Einbausatz

N2919-2



Emblem

N2920

Scheinwerfer H4

N2732

▶ Ersatzlampe H4

091 412 004



Plus Serie Karosserie

Beschreibung

Referenz

Bestellnummer

Preis €

Feder
für Frontmaske

288 57 057
1288 57 057

523 100 027

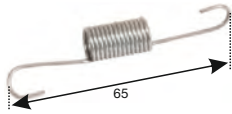

passend für:
Plus Serie

Haken
für Frontmaske

288 35 047
1288 35 047

523 100 028



passend für:
Plus Serie

Schlauchstück
zur Befestigung der Frontmaske

900 0348 9246

523 100 246

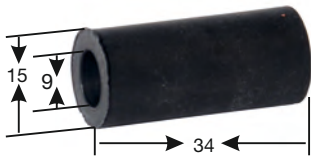

passend für:
Plus Serie



Kotflügel vorne
rechts inkl. Haltebügel

N2953-9

passend für:
Plus Serie



Kotflügel vorne
links inkl. Haltebügel

N2954-9

passend für:
Plus Serie

Plus Serie Karosserie

Beschreibung

Referenz

Bestellnummer

Preis €



Seitenteil

Rechts
Links

396 13 0005
396 13 0006

523 120 005
523 120 006

passend für:
50, 650, 658, 60, 760, 768



Gummiteil
zur Befestigung der seitlichen
Motorabdeckung

293 13 0066

523 100 066



passend für:
Plus Serie



Gummipuffer
zur Befestigung der seitlichen
Motorabdeckung

293 13 0067

523 100 067

passend für:
Plus Serie

Plus Serie Karosserie

Beschreibung

Referenz

Bestellnummer

Preis €



Kotflügel hinten
grau grundiert

Rechts
Links

523 140 508
523 140 509

passend für:
40, 540, 545, 548

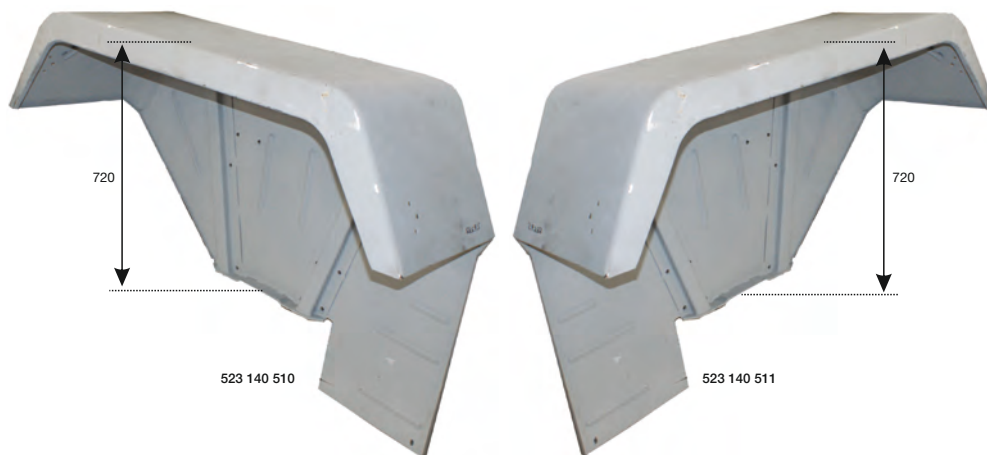

Kotflügel hinten
grau grundiert

Rechts
Links

523 140 510
523 140 511







passend für:
50, 650, 658, 60, 760, 768







	Beschreibung	Referenz	Bestellnummer	Preis €
	Alternator LETRIKA (Iskra) 14V 65A passend für: 8045 WD308.48 1988-1990 türkischen Motor	308 0009 0032	201 252 511	
	Alternator LETRIKA/ (Iskra) 14V 33A ► Anschlussstecker 2-Polig passend für: 8055 WD311.44 1982 8060 WD311.40 1980 8065 WD311.45 1986 8070 WD411 1992 8075 WD411 1992 8080 WD411 1980 8085 WD411.92 1992 8090 WD411 1983-1992 8095 WD411 1992	1311 0009 0005	IA0062	345 002 002
	Alternator LETRIKA (Iskra) 14V 65A LETRIKA (Iskra) 14V 85A ► Anschlussstecker 3-Polig passend für: 8100 WD611.40 1978-1984 8110 WD611.43 1984-1987 8120 WD411 1978-1984 8130 WD611 1984-1987 8140 WD612.40 1977-1981 8150 WD612.87 1982-1993 8160 WD612.85 1976-1981 8165 WD612.86 1986 8170 WD612.89 1981-1988 8180 WD612.96 1986-1993 8300 WD615.84 1982-1987 8320 WD615.85 1987-1993	1311 0009 0055 1301 0009 0005	IA0499 IA0914	345 003 001
	Keilriemen passend für: 8055, 8060, 8070, 8080, 8090 8075, 8110, 8120, 8130, 8140, 8160	9,5 x 1175 mm 9,5 x 1325 mm	097 101 175 097 101 325	
	Regler für Bosch Alternator 33A passend für: Serie 80	1 197 311 090	H130 507	

Serie 80 Elektrik

	Beschreibung	Referenz	Bestellnummer	Preis €
	Regler für ISKRA Alternator 33A passend für: Serie 80	AER1515 AER1528 AER1543	H130 511	
	Regler für ISKRA Alternator 65A (IA0499) passend für: Serie 80	AER1556 AER1560 AER1588	210 212 556	
	Regler für MAGNETI MARELLI Alternator passend für: Serie 80	RTT119A RTT119AC	H130 790	
	Regler für MAGNETON Alternator passend für: Serie 80	0136131	210 211 131	
	Starter 12V 2,5 KW 11Z passend für: 8045 WD308.48 1988-1990	308 0900 02	N0585	
	Starter LETRIKA (Iskra) 12V 3,0 KW 9Z UMLAUFF 12V 3,0 KW 9Z BOSCH Tausch 12V 3,0 KW 9Z passend für: 8055 WD311 8060 WD311.40 1980 8065 WD311.85 1986 8070 WD411 1992 8075 WD411 1992 8080 WD411 1980 8085 WD411.92 1992 8090 WD411 1983-1992 8095 WD411 1992	411 0009 0015 411 0009 0007	IS0671 AIS0671 992149 Kaution	i auf Anfrage auch mit 9 Volt-Anker lieferbar für 1/3 mehr Drehmoment!

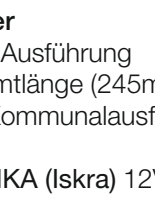
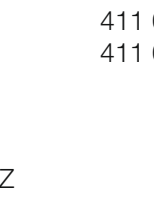
Serie 80 Elektrik

	Beschreibung	Referenz	Bestellnummer	Preis €
	<p>Starter kurze Ausführung Gesamtlänge (245mm) z.B. Kommunalausführung</p> <p>LETRIKA (Iskra) 12V 2,7 KW 9Z</p> <p>passend für: 8060 WD311.40 1980 8065 WD311.85 1986</p>	<p>411 0009 0015 411 0009 0007</p>	<p>IS0709</p>	
	<p>Starter</p> <p>LETRIKA (Iskra) 12V 3,0 KW 9Z</p> <p>BOSCH Tausch 12V 3,0 KW 9Z</p> <p>passend für: 8100 WD611.40 1978-1984 8110 WD611.43 1984-1987 8120 Wd411 1978-1984 8130 WD611 1984-1987</p>	<p>611 0009 0002</p>	<p>IS0254</p>	<p>990863 Kaution</p> <p>i auf Anfrage auch mit 9 Volt-Anker lieferbar für 1/3 mehr Drehmoment!</p>
	<p>Starter</p> <p>LETRIKA (Iskra) 12V 3,0 KW 9Z</p> <p>BOSCH Tausch 12V 3,0 KW 9Z</p> <p>passend für: 8140 WD612.40 1977-1981 8150 WD612.87 1982-1993 8160 WD612.85 1976-1981 8165 WD612.86 1986 8170 WD612.89 1981-1988 8180 WD612.96 1986-1993</p>	<p>412 0009 0001 611 0009 0002</p>	<p>IS0751</p>	<p>990140 Kaution</p> <p>i auf Anfrage auch mit 9 Volt-Anker lieferbar für 1/3 mehr Drehmoment!</p>
	<p>Starter</p> <p>BOSCH Tausch 24V 5,4 KW 11Z</p> <p>passend für: 8300 WD615.84 1982-1987</p>		<p>990657 Kaution</p>	

Serie 80 Elektrik

Beschreibung	Referenz	Bestellnummer	Preis €
 <p>passend für: nur für Anfang der Serie 80</p>	322 115 4 R91	0 342 316 003	
 <p>Glühstartschalter Einbau Ø 26,5 mm P-Parklicht, 0-Aus, 1-Zündung, 2-Vorglühen, 3-Start Klemmen: 58, 15/54, 19, 50a, 17, 30</p> <p>passend für: Serie 80</p>	357 0058 0118	350 883 010	
 <p> <ul style="list-style-type: none"> ▶ Schlüssel ▶ Staubkappe ▶ Stecksockel ▶ Stecksockel ▶ Tülle </p> <p>350 889 603 350 889 604 350 889 605 350 889 606 350 889 607</p>	14603	350 889 603 350 889 604 350 889 605 350 889 606 350 889 607	
 <p>passend für: Serie 80</p>		350 881 003	
 <p>Warnblinkschalter Anschlüsse: 15/30/31/49s/54f/R/L</p> <p>passend für: 8055, 8075</p>	99000580014 299657A1E	350 884 002	
 <p>Öldruckschalter M10 x 1</p>		N600007	
 <p>Bremslichtschalter M10x1</p>		N601 102	

Serie 80 Elektrik

	Beschreibung	Referenz	Bestellnummer	Preis €
	<p>Bremslichtschalter mit Innengewinde 5,6 bis 6,6 bar</p> <p>passend für: 8100</p>		<p>350 890 001</p>	
	<p>Bremslichtschalter für Handbremse</p> <p>passend für: Serie 80</p>	<p>34-743-001</p>	<p>N601 000</p>	
	<p>Unterbrecherschalter</p> <p>passend für: Serie 80</p>	<p>337 0071 0023</p>	<p>N602 511</p>	
	<p>Druckschalter gelb für Arbeitsscheinwerfer</p> <p>passend für: Serie 80</p>	<p>337 0058 0008 1 337 0058 0008</p>	<p>350 872 008</p>	
	<p>Druckschalter grün für Licht</p> <p>passend für: Serie 80</p>	<p>337 0058 0004 1 337 0058 0004</p>	<p>350 872 004</p>	
	<p>Blinkgeber 12V 2+1+1 x 21W</p> <p>passend für: Serie 80</p>	<p>337 0058 0021 1337 0058 0021 1-40-258-106</p>	<p>N432 160</p>	
	<p>Vorglühmagnetschalter</p> <p>passend für: Serie 80</p>	<p>337 0071 0201</p>	<p>300 802 201</p>	

Serie 80 Elektrik







Beschreibung	Referenz	Bestellnummer	Preis €
	Vorglühschraube	311 0009 0024 0 251 102 002	GH 760
passend für: Serie 80			
	Gebläsemotor	347 84004 1347 84004	350 211 004
passend für: Serie 80			
	Gebläse	350 211 800	
passend für: Serie 80 SK2 Komfortkabine			
	Traktormeter Ø 80 mm	357 0058 0008	N2675-9
passend für: Serie 80			
	Dichtgummi für Traktormeter	N2675-8	
	Traktormeterwelle mit Winkeltrieb Länge 1700 mm	190 58 0061	N2679
Traktormeterwelle ohne Winkeltrieb Länge 2100 mm (für Länge 1700 mm verwendbar)			N2679-1
	Winkeltrieb	92 58 0016	N2680

Serie 80

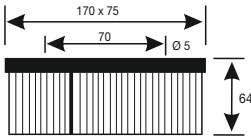
Elektrik/Beleuchtung

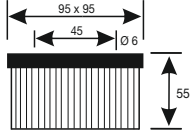
Beschreibung	Referenz	Bestellnummer	Preis €
 <p>Kuppler</p> <p>passend für: Serie 80</p>	311 0001 0191	350 213 191	
 <p>Wischemotor</p> <p>passend für: Serie 80</p>	0 390 216 713	350 210 713	
Beleuchtung			
 <p>Scheinwerfer Befestigung: Einbau</p> <p>passend für: 8045, 8055, 8060, 8065, 8070, 8075</p> <p>Ⓔ</p>	34-172-007 W149	100 400 149	
	▶ Scheinwerferlampe 12V 45/40W P45t	091 512 006	
 <p>Scheinwerfer Abmessung: 173 x 142 mm Befestigung: Schraube M8</p> <p>Ⓔ</p>	Bilux Ausführung	34-172-013 W177	100 400 177
	▶ Scheinwerferlampe 12V 45/40W P45t	091 512 006	
	▶ Kugellampe 12V 4W Ba9s	091 712 016	
	H4 Ausführung	34-172-040 W177/H4	100 400 181
	▶ Scheinwerferlampe 12V H4 P43t	091 412 004	
	▶ Kugellampe 12V 4W Ba9s	091 712 016	

Serie 80 Beleuchtung

Beschreibung	Referenz	Bestellnummer	Preis €
 <p>ⓔ</p>	<p>Blink-, Positionsleuchte Links und Rechts verwendbar</p>		<p>100 204 022 100 254 003 091 612 010 091 612 014</p>
 <p>ⓔ</p>	<p>Blink-, Positionsleuchte Links Rechts</p>		<p>100 204 025 100 204 024 100 254 004 091 612 010 091 612 014</p>
 <p>ⓔ</p>	<p>Schluss-, Brems-, Blinkleuchte Abmessung: 170 x 75 x 64 mm Befestigung: 2 x M5 Schrauben Lochabstand: 70 mm mit Rückstrahler</p>	<p>34-176-048 34-176-047</p>	<p>100 100 102 100 100 101 100 150 096 091 612 008 091 612 014</p>
 <p>ⓔ</p>	<p>Schluss-, Brems-, Blinkleuchte Abmessung: 170 x 75 x 64 mm Befestigung: 2 x Ø 5,5 mm Loch Lochabstand: 70 mm ohne Rückstrahler</p>	<p>Links mit Kennzeichenbeleuchtung Rechts ohne Kennzeichenbeleuchtung</p>	<p>100 100 104 100 100 103 100 150 097 100 150 098 091 612 010 091 612 014</p>
 <p>ⓔ</p>	<p>Schluss-, Brems-, Blinkleuchte Abmessung: 170 x 70 x 64 mm Befestigung: 2 x Ø 5,5 mm Loch Lochabstand: 70 mm mit Rückstrahler</p>	<p>Links und Rechts verwendbar</p>	<p>100 100 106 100 150 099 091 612 010 091 612 014</p>

Serie 80 Beleuchtung

	Beschreibung	Referenz	Bestellnummer	Preis €
	Schluss-, Brems-, Blinkleuchte Abmessung: 95 x 85 x 54 mm Befestigung: 2 x Ø 5,5 mm Loch Lochabstand: 45mm			
	Links Rechts	34-176-061 34-176-060	100 100 112 100 100 107	
	▶ Lichtscheibe steckbar	34-776-010	100 150 100	
	▶ Kugellampe 12V 21W Ba15s ▶ Kugellampe 12V 10W Ba15s		091 612 010 091 612 012	
	Rückstrahler PVC rechteckig Abmessung: 90 x 75 mm Befestigung: Bohrung Ø 5,3mm	34- 176 050	100 622 033	
	Kennzeichenleuchte Steyr CNH Abmessung: 100 x 55 x 57,5 mm Befestigung: 2 Schrauben M5 Schraubenabstand: 45 mm		100 106 001	
	▶ Kugellampe 12V 5W Ba15s ▶ Kugellampe 24V 5W Ba15s		091 612 014 091 624 015	
	Arbeitsscheinwerfer für Dacheinbau passend für: Serie 80 SK2		100 500 586	
	▶ Scheinwerferlampe 12V H3		091 312 002	
	Arbeitsscheinwerfer H3 Abmessung 150 x 230 mm Lichtaustritt: Ø 130mm Befestigung: M10 Schraube, Ω-Bügel u. Gummitülle Glasstreuung mit Handgriff und Schalter		100 500 100	
	▶ Scheinwerferlampe 12V H3 55W Pk22s		091 312 002	
	Arbeitsscheinwerfer H3 Abmessung 105 x 105 x 90 mm Anschluss: 2 x 6,3mm Flachstecker Befestigung: M10 Schraube, Ω-Bügel u. Gummitülle Glasstreuung	098 173 590	100 500 500	
	Mit Schalter	098 173 590	100 500 510	
	▶ Scheinwerferlampe 12V H3 55W Pk22s		091 312 002	

Serie 80 Motor

Beschreibung	Referenz	Bestellnummer	Preis €
	Kurbelwelle	311 0002 0018	500 022 001
passend für: WD311 Motor 8055, 8060, 8065			
	Kurbelwelle	411 0002 0014	500 022 411
passend für: WD411 Motor 8070, 8075, 8080, 8085, 8090, 8095			
	Kurbelwellensimmering vorne	500 122 007	
passend für: WD311/WD411 Motor			
	Kurbelwellensimmering hinten	500 122 008	
passend für: WD311/WD411 Motor			
	Anlaufscheiben-Satz für Kurbelwelle	500 122 107	
passend für: Serie 80 WD311/411/611			
	Zylinderbüchse (Götze)	408 00 04 0032	N0040
passend für: Serie 80 WD311/411/611			
	Büchsenringe	311 00 04 0019	N0041
passend für: Serie 80 WD311/411/611			

Serie 80 Motor

Beschreibung

Referenz

Bestellnummer

Preis €



Ringträgerkolben (NÜRAL Germany) 411 85 03 0705
inkl 38 mm Bolzen
ohne Kolbenringe

N0142-1

passend für:
Serie 80 WD311/411/611



Kolbenring-Setl

N0149-1

passend für:
Serie 80 WD311/411/611



Kolben/Büchsen/Ring-Satz

N0142-KT75

Kolben (NÜRAL Germany)
Büchse (Götze)

passend für:
Serie 80 WD311/411/611

Serie 80 Motor

Beschreibung

Referenz

Bestellnummer

Preis €



Motor Rep-Satz

3 Zylinder WD311

passend für:
8055, 8060, 8065

Set bestehend aus:

Kolben/Büchsen/Satz	3 x N0142-KT75
Büchsenringe	6 x N0041
Pleuellagersatz	1 x N0138-3
Kopfdichtung	1 x 500 121 006
Entrußersatz	1 x 500 118 703

Motor Rep-Satz

4 Zylinder WD411

passend für:
8070, 8075, 8080, 8085, 8090, 8095

Set bestehend aus:

Kolben/Büchsen/Satz	4 x N0142-KT75
Büchsenringe	8 x N0041
Pleuellagersatz	1 x N0138-3
Kopfdichtung	1 x 500 121 008
Entrußersatz	1 x 500 118 701

Motor Rep-Satz







6 Zylinder WD611

passend für:
8100, 8110, 8120, 8130







Set bestehend aus:

Kolben/Büchsen/Satz	6 x N0142-KT75
Büchsenringe	12 x N0041
Pleuellagersatz	2 x N0138-3
Kopfdichtung	1 x 500 121 001
Entrußersatz	1 x 500 118 002

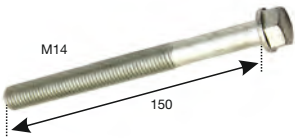
Serie 80 Motor

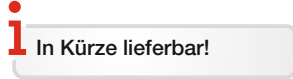
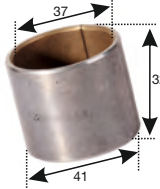
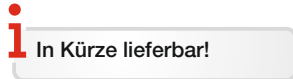
Beschreibung	Referenz	Bestellnummer	Preis €
Pleuellagersatz			
	Standard Übermaß 0,25 mm Übermaß 0,50 mm	1 Satz (4 Paar) 1 Satz (4 Paar) 1 Satz (4 Paar)	N0138-3 N0138-4 N0139-1
passend für: Serie 80 WD311/411/611	 Bei Motor WD611 sind 2 Sätze erforderlich!		
Hauptlagersatz			
	Standard Übermaß 0,25 mm Übermaß 0,50 mm	1 Satz (5 Paar) 1 Satz (5 Paar) 1 Satz (5 Paar)	N0017-1 N0018-1 500 016 501
passend für: Serie 80 WD311/411/611	 Bei Motor WD611 sind 2 Sätze erforderlich!		
Nockenwellenlager			
	passend für: 8055 bis 8090	609 F01 0054	500 123 000
Zylinderkopf			
	für M14 Schrauben passend für: WD411, WD611 8070, 8075, 8080, 8085, 8090 8100, 8120	411 00 04 0003 411 00 04 0004 411 00 04 0015 1411 00 04 0004 1411 00 04 0015	520 020 900
Zylinderkopf komplett			
für M14 Schrauben mit Federn und Ventile passend für: WD411, WD611 8070, 8075, 8080, 8085, 8090 8100, 8120	411 00 04 0003 411 00 04 0004 411 00 04 0015 1411 00 04 0004 1411 00 04 0015	520 020 901	
Zylinderkopf komplett			
	für M14 Schrauben mit Federn und Ventile passend für: WD311 8045, 8055, 8060, 8065	1311 00 04 0003 1311 00 04 0023 1307 040601 308 00 04 0015 1308 00 04 0014	520 020 902

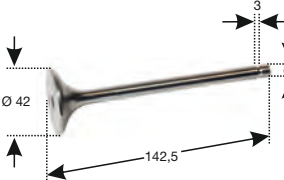





Serie 80 Motor

	Beschreibung	Referenz	Bestellnummer	Preis €
 <p>M14 150</p>	Zylinderkopfschraube M14 passend für: Serie 80	311 00 04 0017	N0159	
	Pleuelstange passend für: Serie 80	xx	500 015 007	
 <p>37 32 41</p>	Pleuelbuchse passend für: Serie 80	1311 00 03 0019	500 015 006	
	Pleuelschraube passend für: Serie 80	406 U03 0002	N0141	
	Ventileinstellschraube passend für: Serie 80	405 05 0024	500 099 001	
 <p>Ø 42 3 Ø 9 142,5</p>	Einlassventil passend für: Serie 80 Motor: WD311/411/611	311 00 05 0014	500 014 005	
 <p>Ø 37 3 Ø 9 142,5</p>	Auslassventil passend für: Serie 80 Motor: WD311/411/611	311 00 05 0015	500 014 006	

Serie 80 Motor

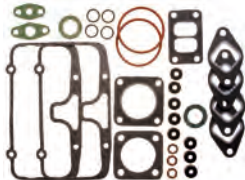
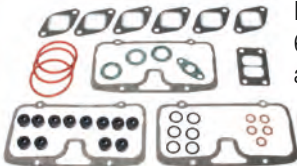
Beschreibung	Referenz	Bestellnummer	Preis €
 <p>Einlassventil Steyr 35° passend für: Serie 80 TURBO</p>	611 6005 0001	500 014 007	
 <p>Auslassventil Steyr 45° passend für: Serie 80 TURBO</p>	611 6005 0002	500 014 008	
 <p>Ventilführung lang für Einlassventil passend für: Serie 80</p>	311 0004 0029	500 114 005	
 <p>Ventilführung kurz für Auslassventil passend für: Serie 80</p>	406 04 0603	500 114 006	
 <p>Stößel passend für: Serie 80</p>	609 05 0002	500 114 001	
 <p>Zahnkranz WD311 WD411/WD611 passend für: Serie 80</p>	2209 0002 0034 610 00 02 0021	520 006 013 526 006 014	
 <p>Zylinderkopfdichtung 3 Zylinder WD311 passend für: 8055, 8060, 8065</p>	311 0004 0070	500 121 006	

Serie 80 Motor

Beschreibung	Referenz	Bestellnummer	Preis €
Zylinderkopfdichtung 4 Zylinder WD411	411 0004 0039	500 121 008	
	passend für: 8070, 8075, 8080, 8075, 8090, 8095		
Zylinderkopfdichtung 6 Zylinder WD611	611 0007 0018	500 121 001	
	passend für: 8100, 8110, 8120, 8130		
Entrußersatz 3 Zylinder WD311 auch für Turbo	311 0001 0703	500 118 703	
	passend für: 8055, 8060, 8065		
Entrußersatz 4 Zylinder WD411 auch für Turbo	411 0001 0701	500 118 701	
	passend für: 8070, 8075, 8080, 8085, 8090, 8095		
Entrußersatz 6 Zylinder WD611 auch für Turbo		500 118 002	
	passend für: 8100, 8110, 8120, 8130		
Ölwannendichtung		500 017 003	
	passend für: Serie 80 Motor WD411		
Ölpumpe	311 00 07 0014 1311 00 07 0014	500 218 014	
	passend für: WD311/411	 In Kürze lieferbar!	

Serie 80 Diesel

Beschreibung

Referenz



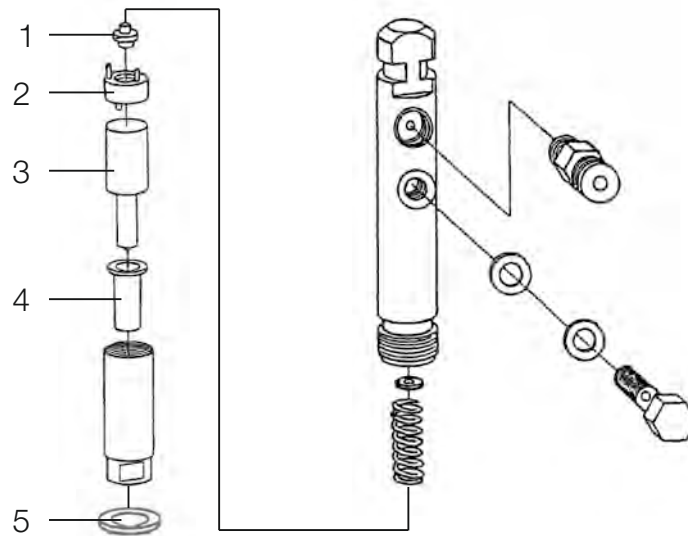

Bestellnummer

Preis €





1 Federteller	311 00 08 0703 9 432 360 800	135 620 800
2 Zwischenstück	311 00 08 0701 9 432 360 080	135 630 080
3 Einspritzdüse		
D1LMK150/55	311 0008 0034 1311 0008 0034 passend für: 8055, 8060, 8065 - WD311) 8080 - WD411.89/90 (53KW) 8090 - WD411.87/88 8130 - WD611.87/88	038 326 746
D1LMK150/54	311 0008 0020 1311 0008 0020 passend für: 8070, 8075 - WD411 8080 - WD411.85/86 (51KW) 8100, 8110, 8120 - WD611	038 326 857
D1LMK150/24	409 00 08 0072 DLLA150S396 passend für: 8140, 8150 - WD612 8160, 8170 - WD612	038 326 205
D1LMK150/53	615 6008 0100 DLLA150S902 passend für: 8300 - WD615.84	038 326 446
4 Wärmeschutzhülse		135 182 004
5 Kupferscheibe		
	Ø 11 x Ø 19 x 1,0 mm	135 751 119
	Ø 11 x Ø 19 x 1,5 mm	135 751 115

Serie 80 Diesel



Beschreibung	Referenz	Bestellnummer	Preis €
 <p>Einspritzdüse</p> <p>passend für: 8165 - WD612.86</p>	<p>612 60 08 0128 DLLA150S1091 0 433 271 731</p>	038 326 731	
 <p>Einspritzdüse</p> <p>passend für: 8320 - WD615.85/87</p>	<p>615 60 08 0218 615 60 08 0178 915 60 08 0148 DLLA150P177 0 433 171 150</p>	038 226 150	
 <p>Förderpumpe Friedmann & Mayer Anschlüsse nach oben mit Schauglas</p> <p>Ausführung ohne Schauglas</p> <p>passend für: 8090 SK1</p>		135 100 039	135 100 038
 <p>Ringnippel</p> <p>passend für: Serie 80</p>	<p>1990 14 23 0017</p>	135 280 017	

Serie 80 Filter

FAHRZEUGTEILE

	Beschreibung	Referenz	Bestellnummer	Preis €
	Filter WD 311			
	passend für: z.B.: 8045, 8055, 8060, 8065			
	Kraftstofffilter	407 08 0074	WK842/2	
	Ölfiler	409 07 0036	W940	
	Luftfilter	311 0019 0020	C13114/4	
Sicherheitspatrone	311 0019 0019	CF600		
	Filter WD 411			
	passend für: z.B.: 8075, 8080, 8090			
	Kraftstofffilter	407 08 0074	WK842/2	
	Ölfiler	409 07 0036	W940	
	Luftfilter	411 8519 0010	C15165/3	
Sicherheitspatrone	411 8519 0007	CF700		
	Filter WD 611			
	passend für: z.B.: 8100, 8130, 8120			
	Kraftstofffilter	407 08 0074	WK842/2	
	Ölfiler	612 0007 0166	W962	
	Luftfilter	611 0019 0028	C17225/3	
Sicherheitspatrone	611 0019 0020	CF800		

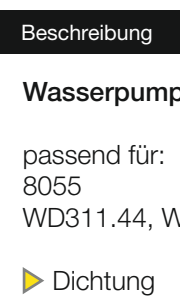
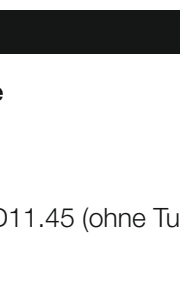
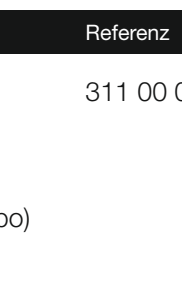
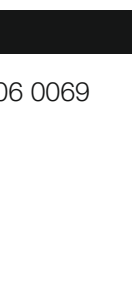
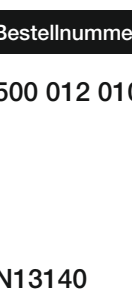
Serie 80 Kühlung

	Beschreibung	Referenz	Bestellnummer	Preis €
	<p>Wasserpumpe</p> <p>passend für: 8055 WD311.44, WD11.45 (ohne Turbo)</p> <p>▶ Dichtung</p>	<p>311 00 06 0069</p>	<p>500 012 010</p>	<p>N13140</p>
 <p>4 Loch</p>	<p>Wasserpumpe mit einfacher Riemenscheibe</p> <p>passend für: 8060, 8065, 8070, 8075 - SK2 8080, 8085, 8090, 8095 - SK2</p> <p>▶ Dichtung</p>	<p>311 0006 0093 1311 0006 0093</p>	<p>500 012 005</p>	<p>N13140</p>
 <p>4 Loch</p>	<p>Wasserpumpe mit doppelter Riemenscheibe</p> <p>passend für: 8060, 8065, 8070, 8075 - SK1 8080, 8085, 8090, 8095 - SK1</p> <p>▶ Dichtung</p>	<p>311 0006 0034 1311 0006 0034</p>	<p>500 012 006</p>	<p>N13140</p>
 <p>6 Loch</p>	<p>Wasserpumpe</p> <p>passend für: 8100, 8110, 8120, 8130</p> <p>▶ Dichtung</p>	<p>611 0006 0017 1611 0006 0017</p>	<p>500 012 007</p>	<p>N13140</p>
	<p>Wasserpumpen Rep-Satz für Wasserpumpen mit loser Lagerwelle</p>	<p>411 00 06 0700</p>	<p>N0241-8</p>	
	<p>Wasserpumpen Rep-Satz für Wasserpumpen mit fixer Lagerwelle</p>	<p>311 00 06 0701</p>	<p>N0241-7</p>	
	<p>Thermostat</p> <p>passend für: Serie 80</p>	<p>311 0006 0065</p>	<p>N0293-2</p>	

Serie 80

Kühlung/Auspuff

Beschreibung	Referenz	Bestellnummer	Preis €
 <p>Kühler</p> <p>passend für: 8060 Sk1, 8060 Turbo Sk1 8070</p>	133700530004 133700530025	500 011 008	
 <p>Kühler</p> <p>passend für: 8075 SK1/SK2</p>	337 0053 0072 337 0053 0230 337 0053 0173 1337 0053 0072 1337 0053 0230 1337 0053 0173	500 011 019	
 <p>Kühler</p> <p>Abmessung 510 x 435 x 71 mm</p> <p>passend für: 8080/8090 SK2</p>	357 0053 0003 357 0053 0017	500 011 014	
 <p>Ringnippel</p> <p>passend für: Serie 80</p>	1990 14 23 0017	135 280 017	

Auspuff

 <p>Auspufftopf</p> <p>passend für: Serie 80 (8080/8090) 8080 SK1/SK2, 8090 Sk2 8060 SK2</p>	1337 0054 0157 1337 0054 0197	526 200 005
--	----------------------------------	--------------------

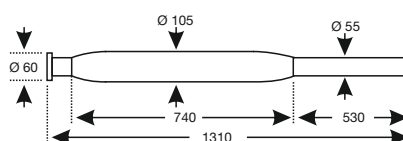

Serie 80 Kupplung

	Beschreibung	Referenz	Bestellnummer	Preis €
	<p>Druckplatte Tausch Sachs mit Zapfwellenkupplungsscheibe Ø 295 mm, 24 Zähne Nabenprofil 280/45x50-24N</p> <p>passend für: 8045/a WD308.48 8060/a WD311.40/41 8060/a WD311.87 (Turbo) 8070/a WD411.41/42</p>	<p>411 0016 0039 411 0016 0095 411 0016 0029 1411 0016 00951</p> <p>geformte Blechhebel ab Fgst Nr 21534 geformter Blechhebel ab Fgst Nr 21525</p>	<p>520 005 001</p> <p>Kaution</p>	
<p>i Bei eingebauter Valeo OE 301 0016 0903 müssen bei der Montage neue Befestigungsschrauben montiert werden!</p>				
	<p>Druckplatte Tausch Sachs Ø 350 mm</p> <p>passend für: 8100/a WD611.40/41 85 PS 8110/a WD611.42/85 90 PS/100 PS Turbo 8120/a WD611.85/86 100 PS Turbo 8130/a WD611.87/88 100 PS Turbo</p>	<p>614 0016 0018 614 0016 0902</p>	<p>520 002 006</p> <p>Kaution</p>	
	<p>Kupplungsscheibe Tausch Sachs für Fahrkupplung Ø 280 mm , 17 Zähne Nabenprofil 28x32-17N</p> <p>passend für: 8055/a WD311.44/45 8055/a WD311.46/47 8060/a WD311.40/41 8060/a WD311.87 (Turbo) 8070/a WD411.43/44</p>	<p>411 0016 925</p> <p>Fgst Nr -10791 und 11004-11106 Fgst Nr 10792- 11003, ab 11107 ab Fgst Nr 21534 ab Fgst Nr 21525</p>	<p>520 001 001</p> <p>Kaution</p>	
	<p>Drucklager Fahrkupplung</p> <p>Drucklager Sachs Drucklager</p> <p>passend für: 8045/a, 8055/a, 8060/a, 8065/a, 8070/a, 8075/a, 8080/a, 8090/a</p>	<p>337 00 21 0065 337 0021 0701 1337 00 21 0065 1337 00 21 0701</p>	<p>520 003 004 520 003 701</p>	
	<p>Drucklager Einfachkupplung</p> <p>passend für: 8100, 8110, 8120, 8130</p>	<p>337 0021 0020 1337 0021 020</p>	<p>520 003 001</p>	

Serie 80

Kupplung/Zapfwelle

Beschreibung	Referenz	Bestellnummer	Preis €
 <p>Drucklager für Zapfwelle</p> <p>Drucklager Sachs Drucklager</p> <p>passend für: 8060, 8080, 8090, 8070 Serie SK</p>	337 00 21 0066 1337 00 21 0066 337 00 021 0702 1337 00 021 0702	520 003 005 520 003 702	
 <p>Drucklager für Zapfwelle</p> <p>passend für: 8055, 8065, 8075 RS Kabine</p>	337 00 23 0701 1337 00 23 0701	520 003 703	
Zapfwelle			
 <p>Zapfwelle</p> <p>passend für: 8045, 8055</p>	337 00 27 0101 1337 00 27 0101	520 007 005	
 <p>Doppelstirnrad</p> <p>passend für: 8045, 8055, 8065, 8075</p>	337 00 27 0078 1337 00 27 0078	520 007 003	
 <p>Gegenstirnrad</p> <p>passend für: 8045, 8055, 8065, 8075</p>	337 00 27 0080 1337 00 27 0080	520 007 004	
 <p>Zapfwellenschutz</p> <p>passend für: Serie 80</p>	288 27 0096	N1415	

Serie 80

Hinterachse/Antrieb

Beschreibung	Referenz	Bestellnummer	Preis €
 <p>Hinterachswelle</p> <p>passend für: 8045</p>	317 003 20015 1 317 003 20015	522 100 009	
 <p>Bremsgehäuse alte Ausführung</p> <p>links rechts</p> <p>passend für: 8045</p>	317 0033 0009 317 0033 0010	524 214 009 524 214 010	
 <p>Bremsgehäuse neue Ausführung</p> <p>links rechts</p> <p>passend für: 8055, 8065, 8075, 8085, 8095 mit RS-Kabine</p>	1295 330020 1295 330022	524 214 020 524 214 022	
 <p>Zahnkranz für Hinterachse</p> <p>passend für: 8075, 8080, 8090 SK1</p>	337 00 32 0060 1337 00 32 0060	522 400 060	
 <p>Planetenrad für Hinterachse</p> <p>passend für: 8075, 8080 SK1</p>	337 00 32 0058 1337 0 032 0058	522 400 058	
 <p>Bolzen</p> <p>passend für: Serie 80</p>	337 00 32 0063 1337 00 32 0063	522 400 063	

Serie 80



Hinterachse/Antrieb

	Beschreibung	Referenz	Bestellnummer	Preis €
	<p>Nadellager</p> <p>passend für: Serie 80</p>	337 00 32 0061	522 100 061	
	<p>Tellerrad und Ritzel verbesserte Ausführung mit Schmierloch</p> <p>passend für: 8060, 8070</p>	337 0032 0079 337 0032 0158 337 0032 0219 1 337 0032 0158 1 337 0032 0219	522 100 603	
	<p>Ritzelachse</p> <p>passend für: 8045</p>	317 00 32 00 01	522 400 001	

Serie 80 Bremse

Beschreibung	Referenz	Bestellnummer	Preis €
 <p>Bremsbacke</p> <p>passend für: 8045</p>	317 00 34 0008 317 00 34 0014 1317 00 34 0014	524 200 014	
 <p>Bremsbacke</p> <p>passend für: 8060, 8070, 8080, 8090</p>	337 00 34 0912 1337 00 34 0912	524 200 912	
 <p>Bremsbacke Handbremse</p> <p>passend für: 8060, 8070, 8080, 8090</p>	337 00 34 0913 1337 00 34 0913	524 200 913	
 <p>Bremsbacke</p> <p>passend für: 8055, 8065, 8075, 8085, 8095 8100, 8110, 8120, 8130</p>	337 00 34 0914 1337 00 34 0914	524 200 914	
 <p>Bremsbacke Handbremse</p> <p>passend für: 8100, 8110, 8120, 8130</p>	377 00 34 9709 1377 00 34 9709	524 200 709	
 <p>Bremsfeder</p> <p>passend für: Serie 80</p>	288 34 0042	N2008	
 <p>Bremsbelagsatz (4Stk) Originalqualität</p> <p>passend für: 8100, 8110, 8120, 8130</p>	377 00 44 1018 1377 00 44 1018	524 211 018	

Serie 80 Bremse

	Beschreibung	Referenz	Bestellnummer	Preis €
	<p>Bremsstrommel 23 Zähne</p> <p>passend für: 8045</p>	<p>317 00 34 0001 1317 00 34 0001</p>	<p>524 100 032</p>	
	<p>Bremsstrommel feine Verzahnung (23 Zähne)</p> <p>passend für: 8055, 8065, 8075, 8085 SK1</p>	<p>295 34 0031</p> <p>i Nur mit mechanischer Bremse!</p>	<p>524 100 031</p>	
	<p>Bremsattel links Originalqualität</p> <p>passend für: 8100, 8110, 8120, 8130</p>	<p>377 00 34 9135 377 00 34 9041 377 00 34 9111 1377 00 34 9135 1377 00 34 9041 1377 00 34 9111</p>	<p>524 217 001</p>	
	<p>Bremsattel rechts Originalqualität</p> <p>passend für: 8100, 8110, 8120, 8130</p>	<p>377 00 34 9136 377 00 34 9042 377 00 34 9112 1377 00 34 9136 1377 00 34 9042 1377 00 34 9112</p>	<p>524 217 002</p>	
	<p>Bremssschlauch M12 x 1 450 mm</p> <p>passend für: Serie 80</p>	<p>90003559720 190003559720 1-34-735-001</p>	<p>524 213 001</p>	
	<p>Bremssschlauch M12 x 1 320 mm</p> <p>passend für: Serie 80</p>	<p>90003559721 190003559721</p>	<p>524 213 002</p>	
	<p>Radbremszylinder Originalqualität</p> <p>passend für: Serie 80</p>	<p>337 00 034 0034</p>	<p>524 215 535</p>	

Serie 80 Bremse



	Beschreibung	Referenz	Bestellnummer	Preis €
	<p>Repsatz für Radbremszylinder (ohne Kolben)</p> <p>passend für: Serie 80</p>	337 00 034 0701	N28048	
	<p>Hauptbremszylinder Originalqualität</p> <p>passend für: 8060/a, 8070/a, 8080/a, 8090/a</p>	357 00 35 0013 357 00 35 0001 1357 00 35 0013 1357 00 35 0001	524 216 013	
	<p>Hauptbremszylinder Originalqualität</p> <p>passend für: 8110, 8120, 8130, 8140 8150, 8160, 8165, 8170, 8180</p>	37700357055 137700357055	524 216 055	
	<p>Handbremshebel</p> <p>passend für: 8055, 8075</p>	292 35 0053	524 900 053	
	<p>Sperrklinke für Handbremshebel</p> <p>passend für: 8055, 8075, 8085, 8095</p>	390 35 0055 1390 35 0055	N1210	
	<p>Handbremssegment</p> <p>passend für: 8055, 8075, 8085, 8095</p>	292 35 0120 1292 35 0120	N1921	
	<p>Bolzen für Handsegment N1921 Feststellbremse</p> <p>passend für: 8055, 8075, 8085, 8095</p>	288 35 0019 1288 35 0019	N1928	

Serie 80



Bremse/Lenkung

	Beschreibung	Referenz	Bestellnummer	Preis €
 <p>oben/unten M22x1,5 M22x1,5 M22x1,5 Ø10</p>	Schnellentüftungsventil Betriebsdruck: 10 bar passend für: 8160, 1400	990 0035 0057 1990 0035 0057	524 214 002	
	Ringnippel passend für: Serie 80	1990 14 23 0017	135 280 017	

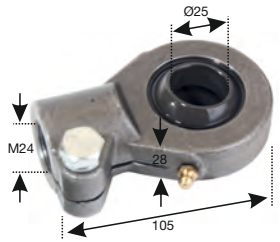
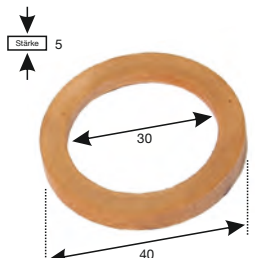
Lenkung

	Lenkrad passend für: Serie 80	33-147-270	N2075-6	
	Abdeckkappe für Lenkrad N2075-6	92 47 0003	N92470003	
 <p>M24 Ø25 28 105</p>	Gelenkkopf M24 x 1,5 passend für: 8055, 8060, 8070, 8075 8080, 8090, 8100, 8120	377 0047 0066 377 0047 0109 377 0047 0114 377 0047 0144 1377 0047 0066 1377 0047 0109 1377 0047 0114 1377 0047 0144	522 300 001	
 <p>Stärke 5 30 40</p>	Dichtring für Gelenkkopf passend für: 8055, 8060, 8070, 8075 8080, 8090, 8100, 8120	377 0047 0103 1377 0047 0103	522 300 103	

Serie 80 Achse

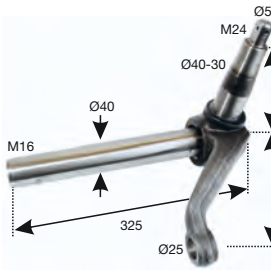
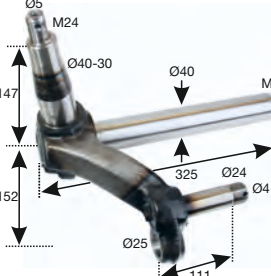
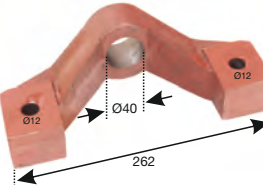
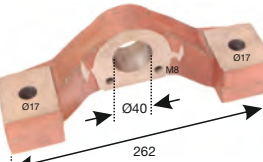
	Beschreibung	Referenz	Bestellnummer	Preis €
	<p>Anlaufscheibe klein für Vorderachse</p> <p>passend für: Serie 80</p>	1 357 0041 0063	522 100 163	
	<p>Anlaufscheibe groß für Vorderachse</p> <p>passend für: Serie 80</p>	1 397 41 281	522 100 281	
	<p>Achsschenkel links für starre Achse</p> <p>passend für: 8045 bis 8090</p>	337 0041 0247 1 337 0041 0247	522 100 033	
	<p>Achsschenkel rechts für starre Achse</p> <p>passend für: 8045 bis 8090</p>	337 0041 0245 1 337 0041 0245	522 100 034	
	<p>Lagerbock</p> <p>passend für: 8045</p>	317 0041 0002	522 100 037	
	<p>Lagerbock</p> <p>passend für: 8045</p>	317 0041 0004	522 100 038	

Serie 80 Allrad

Beschreibung

Referenz

Bestellnummer

Preis €

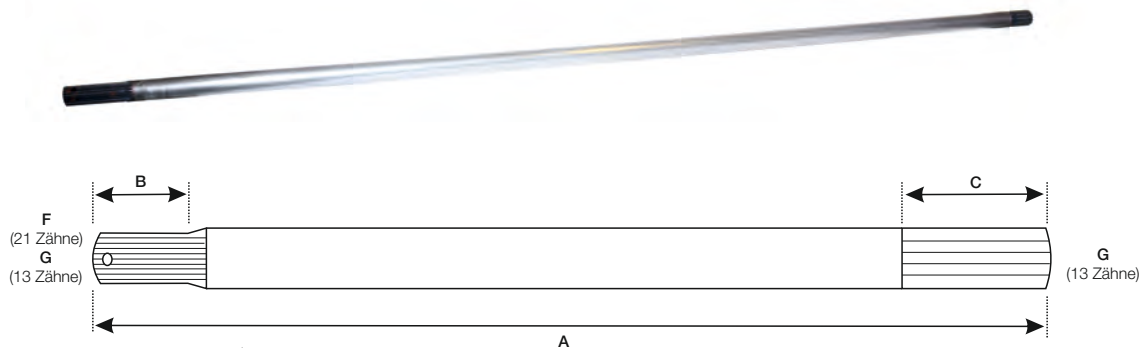

Antriebswelle für Vorderachse Allrad

passend für:	A	B	C	Modul vorne	Modul hinten	
8060a SK1	1555 mm**	85 mm	**	G	G	522 401 001**
	** Universalachse (1710 mm) C auf Gesamtlänge A 1555 mm kürzen					
8060a SK2	1555 mm**	85 mm	**	F	G	522 401 002**
	** Universalachse (1610 mm) C auf Gesamtlänge A 1555 mm kürzen					
8070a SK2 ZF APL 325 Achse	1670 mm	85 mm	170 mm	F	G	522 401 003
	OE Steyr Nr.: 1357 00 31 0076					
8075a SK1 ZF APL 325 Achse	1575 mm**	85 mm	**	F	G	522 401 002**
	** Universalachse (1610 mm) C auf Gesamtlänge A 1575 mm kürzen					
8080/8090a SK1 ZF APL 325 Achse	1605 mm	85 mm	50 mm	F	G	522 401 004
	OE Steyr Nr.: 1357 00 31 0013					
8080/8090a SK2 ZF APL 325 Achse	1550 mm	85 mm	**	F	G	522 401 002**
	OE Steyr Nr.: ** Universalachse (1610 mm) C auf Gesamtlänge A 1550 mm kürzen					
Universal zum Kürzen auf gewünschte Länge	1610 mm	85 mm	165 mm	G	G	522 401 001
	C ist auf gewünschte Gesamtlänge zu kürzen					
Universal zum Kürzen auf gewünschte Länge	1675 mm	85 mm	165 mm	F	G	522 401 002
	C ist auf gewünschte Gesamtlänge zu kürzen					

Serie 80

Allrad/Hydraulik







	Beschreibung	Referenz	Bestellnummer	Preis €
	<p>Flansch vorderachse mit Allrad alte Ausführung für ZF- Achse grobe Verzahnung 13 Zähne, 8 Loch</p> <p>passend für: Serie 80</p>	<p>337 0031 0014 1337 0031 0014</p>	<p>522 100 031</p>	
	<p>Muffe Vorderachse mit Allrad neue Ausführung für SIGE Achse feine Verzahnung 21 Zähne</p> <p>passend für: Serie 80</p>	<p>357 0042 1018 1357 0042 1018</p>	<p>522 100 032</p>	
	<p>Flansch mit Gehäusehalterung und Lager</p> <p>passend für: Serie 80 Allrad</p>	<p>357 00 31 0015 1357 00 031 0015</p>	<p>522 100 015</p>	
	<p>Muffe hinten für Allrad 13 Zähne</p> <p>passend für: Serie 80</p>	<p>337 00 29 0258 1337 00 29 0258</p>	<p>522 100 258</p>	
Hydraulik				
	<p>Hydraulikpumpe</p> <p>passend für: 8055</p>	<p>0 510 410 322 0 510 415 313 0 510 415 316</p>	<p>521 010 003</p>	
	<p>Hydraulikpumpe</p> <p>passend für: 8090/a, 8100</p>	<p>0 510 515 310</p>	<p>521 010 007</p>	
	<p>Hydraulikpumpe</p> <p>passend für: 8055, 8060, 8070, 8075, 8080, 8090, 8100, 8120, 8120a, 8160, 8170</p>	<p>0 510 615 321 0 510 615 337</p>	<p>521 010 008</p>	

Serie 80 Hydraulik

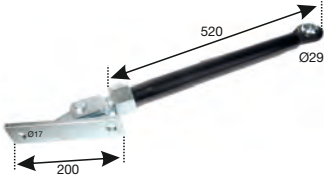
	Beschreibung	Referenz	Bestellnummer	Preis €
	<p>Anlenkblock</p> <p>passend für: Serie 80</p>	<p>292 73 0051 1292 73 0051</p>	<p>522 200 051</p>	
	<p>Hubstrebe 42 mm Gabelbreite</p> <p>passend für: Serie 80</p>		<p>522 200 005</p>	
	<p>Hubstrebe</p> <p>passend für: 8100-8130</p>		<p>522 200 002</p>	
	<p>Bolzen für Hubstrebe 522 002 002 und 005</p>		<p>522 200 105</p>	
	<p>Gelenksstück</p> <p>passend für: teilweise 8045, 8055</p>	<p>190 74 0196</p>	<p>522 200 011</p>	
	<p>Gelenksstück</p> <p>passend für: teilweise 8045, 8055</p>	<p>292 74 0078</p>	<p>522 200 010</p>	
	<p>Seitenstrebe 530-660 mm</p> <p>passend für: Serie 80</p>		<p>N2622-1</p>	

Serie 80

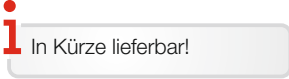
Hydraulik/Karosserie

Beschreibung	Referenz	Bestellnummer	Preis €
 <p>Seitenstrebe Gewinde Ø 32 mm passend für: Serie 80</p>		522 200 013	
 <p>Hubstrebe passend für: Serie 80</p>	295 74 0501	N2546	
 <p>Ackerschiene passend für: Serie 80</p>	337 00 74 0051 1337 00 74 0051	522 200 004	
Karosserie			
 <p>Emblem passend für: Serie 80</p>		N2920	
 <p>Anschlaggummi für Motorabdeckung passend für: z.B.: 8060 bis 8130</p>		523 100 041	
 <p>Spiegel passend für: Serie 80 SK1</p>	97 77 0100	N722 000	
 <p>Spiegel ▶ Spiegelglas passend für: Serie 80 SK2</p>	34 177 178 34 777 002	N722 510 N722 511	

Serie 80 Karosserie

Beschreibung	Referenz	Bestellnummer	Preis €
--------------	----------	---------------	---------



Dachscheinwerfergehäuse
vorne

1-34-272-030

523 100 030

passend für:
8045 bis 8130 SK2

i Nachrüstung für SK1-
Kabinen möglich!



Dachscheinwerfergehäuse
hinten

1-34-272-050

523 100 031

passend für:
8045 bis 8130 SK2

i Nachrüstung für SK1-
Kabinen möglich!



Scheinwerfer
für Dacheinbau

34-172-007
W149

100 400 149

passend für:
8045, 8055, 8060, 8065, 8070, 8075

Ⓔ

▶ Scheinwerferlampe 12V 45/40W P45t

091 512 006



Arbeitsscheinwerfer
für Dacheinbau

100 500 586

passend für:
Serie 80 SK2

▶ Scheinwerferlampe 12V H3

091 312 002



Druckschalter gelb
für Arbeitsscheinwerfer

337 0058 0008
1 337 0058 0008

350 872 008

passend für:
Serie 80

Serie 80 Karosserie

Beschreibung

Referenz

Bestellnummer

Preis €



Kotflügel hinten unlackiert
2 mm Stärke (Original 1,8 mm)
aus einem Teil gefertigt

i ACHTUNG:
Versandkosten-Pauschale!

links
rechts

1-34-425-101
1-34-425-102

523 140 513
523 140 514

passend für:
8045, 8055



Kotflügel hinten unlackiert
2 mm Stärke (Original 1,8 mm)
aus einem Teil gefertigt

i ACHTUNG:
Versandkosten-Pauschale!

links
rechts

1-34-425-202
1-34-425-213
1-34-425-201

523 140 501
523 140 502

passend für:
8065, 8075, 8085, 8095

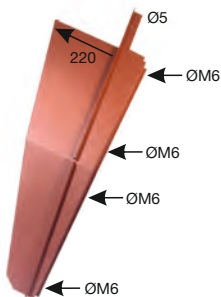

Kotflügelverbreiterung grundiert
vorne, breite Ausführung 220 mm

links
rechts

523 100 039
523 100 040

passend für:
8065, 8075, 8085, 8095

i ACHTUNG:
Versandkosten-Pauschale!

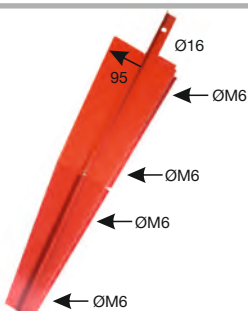

Kotflügelverbreiterung lackiert
vorne, schmale Ausführung 95mm

links
rechts

1-34-701-492
1-34-701-493

523 100 035
523 100 036

passend für:
8045, 8055, 8065,
8075, 8085, 8095

i ACHTUNG:
Versandkosten-Pauschale!

Serie 80 Karosserie

Beschreibung

Referenz

Bestellnummer

Preis €

Kotflügel 3 teilig

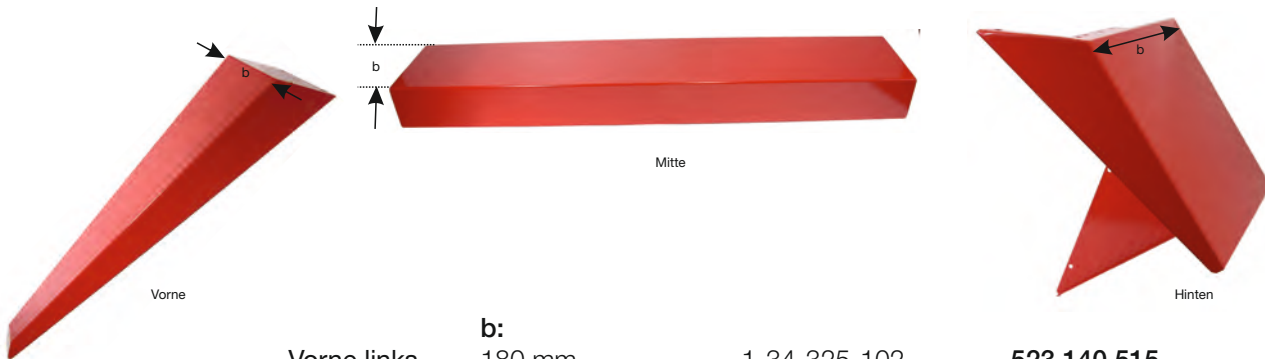

	b:		
Vorne links	180 mm	1-34-325-102	523 140 515
Vorne rechts	180 mm	1-34-325-101	523 140 516
Mitte	180 mm	1-34-125-080	523 140 517
Hinten links	430 mm	1-34-325-104	523 140 518
Hinten rechts	430mm	1-34-325-103	523 140 519

passend für:
8060, 8070, 8080, 8090

i ACHTUNG:
Versandkosten-Pauschale!

	b:		
Vorne links	265 mm	1-34-325-116	523 140 520
Vorne rechts	265 mm	1-34-325-115	523 140 521
Mitte	265 mm	1-34-125-082	523 140 522
Hinten links	520 mm	1-34-325-114	523 140 523
Hinten rechts	520mm	1-34-325-113	523 140 524

passend für:
8070 teilweise, 8080, 8090

i ACHTUNG:
Versandkosten-Pauschale!

	b:		
Vorne links	350 mm	1-34-325-118	523 140 525
Vorne rechts	350 mm	1-34-325-117	523 140 526
Mitte	350 mm	1-34-125-083	523 140 527
Hinten links	610 mm	1-34-325-110	523 140 528
Hinten rechts	610mm	1-34-325-109	523 140 529

passend für:
8100, 8110, 8120, 8130

i ACHTUNG:
Versandkosten-Pauschale!

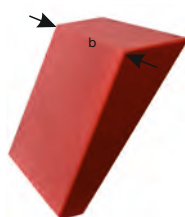

Vorne kurz
523 140 530

	b:		
Vorne kurz links	390 mm		523 140 530
Vorne kurz rechts	390 mm		523 140 531
Vorne lang links	390 mm	1-34-325-120	523 140 532
Vorne lang rechts	390 mm	1-34-325-119	523 140 533
Mitte	390mm	1-34-125-083	523 140 534
Hinten links	640 mm	1-34-325-112	523 140 535
Hinten rechts	640mm	1-34-325-111	523 140 536

passend für:
8130

i ACHTUNG:
Versandkosten-Pauschale!

Serie 80

Karosserie

Beschreibung	Referenz	Bestellnummer	Preis €
 <p>Heckplane</p> <p>passend für: 8045-8075</p>	1-34-468-032	523 130 006	
 <p>Verschluss für Heckplane</p> <p>passend für: 8045-8075</p>	1191S 670016	523 130 106	
 <p>Gasdämpfer</p> <p>Heckscheibe 590 mm Dachluke</p> <p>passend für: Serie 80</p>	99-976-047 99-976-036	523 130 047 523 130 036	



Serie 900/9000

Elektrik

Beschreibung	Referenz	Bestellnummer	Preis €
--------------	----------	---------------	---------



Alternator

308 009 0032

201 252 511

LETRIKA (Iskra) 14V 65A

passend für:

942 türkischen
948 Motor



Alternator

LETRIKA (Iskra) 14V 65A

311 0009 0065

IA0499

LETRIKA (Iskra) 14V 80A

311 0009 0005

IA0914

LETRIKA (Iskra) 14V 120A

311 0009 006

IA1153

passend für:

955 MWM 1992-1997
964 MWM 1992-1997
970 MWM 1992-1997
M968 MWM 1994-2004
M975 MWM 1998-

9078 MWM 1993-1995
9083 MWM Turbo 1993-1995
9086 MWM 1993-1995
9094 MWM

M9078 MWM
M9083 MWM
M9086 MWM
M9094 MWM



Alternator

UMLAUFF 14V 70A

201 210 005

passend für:

M948 Perkins
M952 Motor
M958
M963

9155 Perkins
9160 Motor
9170
9180
9190
9200

Serie 900/9000 Elektrik

Beschreibung	Referenz	Bestellnummer	Preis €	
Alternator				
	MAGNETON OE	14V 65A	320 0009 065	N391102
	MAGNETON OE	14V 95A	320 0009 095	N390112
	MAGNETON OE	14V 120A	320 0009 120	N390122
	passend für:			
	M968	SISU/Valmet		
	M975	SISIU/Valmet		
	M9078	SISU/Valmet		
	M9086	SISU/Valmet		
	M9094	SISU/Valmet		
	9080M			
9080M				
9090M				
9100M				
9105	WD420			
9115	Wd620			
9125	WD620			
9145	WD620			
<hr/>				
Alternator				
	LETRIKA (Iskra)	14V 120A		IA1087
	innenbelüftet			
passend für:				
9080MT				
9085MT				
9090MT				
9095MT				
9100MT				
9105MT				
<hr/>				
Regler				
	für MAGNETI MARELLI Alternator	RTT119A RTT119AC		H130 790
	passend für:			
942, 948				
<hr/>				
Regler				
	für ISKRA Alternator	65A (IA0499) 80A (IA0914)	AER1556 AER1560 AER1588	210 212 556
	passend für:			
900/9000 mit MWM Motor				

Serie 900/9000

Elektrik

Beschreibung	Referenz	Bestellnummer	Preis €
	Regler für ISKRA Alternator 120 A (IA1153)	11 125 221 11 125 262	H130 519
passend für: 900/9000 Serie mit MWM Motor			
	Regler für Alternator 70A (201 250 005)	H130 820	
passend für: M948-M963 mit Perkins Motor 9155-9200 mit Perkins Motor			
	Regler für MAGENTON Alternator 65A N391 102	0136131	210 211 131
passend für: 900/9000 Serie mit SISU/VALMET Motor			
	Regler für MAGENTON Alternator 95A N390 112	0136111	210 211 111
passend für: 900/9000 Serie mit SISU/VALMET Motor			
	Regler für MAGENTON Alternator 120A N390 122	0138841	210 211 841
passend für: 900/9000 Serie mit SISU/VALMET Motor			
	Regler für LETRIKA 120A IA0952 la1087	16 908 833	210 212 033
passend für: 9080MT-9105MT			

Serie 900/9000

Elektrik

Beschreibung	Referenz	Bestellnummer	Preis €
--------------	----------	---------------	---------



Starter	12V 2,5 KW 11Z	207 090002	N0585
----------------	----------------	------------	--------------

passend für:
942 türkischen Motor
948



Starter		605 720 00071	
----------------	--	---------------	--

LETRIKA (Iskra) 12V 3,0 KW 9Z **IS0670**



MAGETON 12V 3,0 KW 9Z **25-0337MG**
Getriebeausführung

passend für:

955	MWM	1992-1997
964	MWM	1992-1997
970	MWM	1992-1997
M968	MWM	1994-2004
M975	MWM	1998-
9078	MWM	1993-1995
9083	MWM Turbo	1993-1995
9086	MWM	1993-1995
9094	MWM	
M9078	MWM	
M9083	MWM	
M9086	MWM	
M9094	MWM	



Starter		303 0009 0701 1 303 0009 0701	200 290 898 Kaution
----------------	--	----------------------------------	--------------------------------------

LUCAS Tausch 12V 2,8 KW 10Z

LETRIKA (Iskra) 12V 3,2 KW 10Z **IS1393**
Getriebeausführung

passend für:
M948 Perkins
M952 Motor
M958

Serie 900/9000

Elektrik

Beschreibung	Referenz	Bestellnummer	Preis €
--------------	----------	---------------	---------



Starter

1420 0009 0700

LETRIKA (Iskra) 12V 3,2 KW 10Z

IS0897

LETRIKA (Iskra) 12V 4,2 KW 11Z

IS0836

Getriebeausführung

passend für:

M968 SISU/Valmet

M975 SISU/Valmet

M9078 SISU/Valmet

M9086

M9094 ab Fgst DBD

9080M

9080MT

9080M

9085MT

9090M

9090MT

9095MT

9100M WD420

9100MT Wd620

9105 WD620

9115 WD620

9125

9145



Starter

LETRIKA (Iskra) 12V 2,8 KW 10Z

LRS195

LETRIKA (Iskra) 12V 4,2 KW 10Z

IS1160

Getriebeausführung

passend für:

9155 WD620 Turbot 993-1995

9160 WD620

9170 WD620 Turbot 993-1995

9180 WD620

9190 WD634

9200 WD634



Lenkstockschalter

350 881 001

Lenksäule Ø 45 mm

passend für:

Serie 900/9000



Öldruckschalter

301 00 09 0781

350 890 781

M10 x1 zylindrisch

passend für:

Serie 900/9000

Serie 900/9000 Elektrik

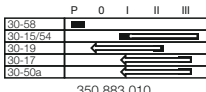
	Beschreibung	Referenz	Bestellnummer	Preis €
	Relais 12V/30A für Standlicht	70REF384	WE20 207 103A	
	passend für: 968			
	Relais	1-40-258-111 84543528	WE29 201 075A	
	passend für: 9000/9100			
	Blinkgeber 12V 2+1+1 x 21W	337 0058 0021 1337 0058 0021 1357 00 58 0020 1-40-258-106	N432 160	
	passend für: Serie 80			
	Leistungsstecker 3-Polig Flachstecker		ME006818.00	
	passend für: Serie 900/9000			
	Leistungssteckdose 3-Polig, 2-Loch Befestigung Flachstecker		ME006817.00	
	passend für: Serie 900/9000			
	Glühstartschalter Einbau-Ø 26,5 mm P-Parklicht, 0-Aus, 1-Zündung, 2-Vorglühen, 3-Start.			
	für Digitalanzeige		350 883 016	
	für mechanische Anzeige		350 883 010	
	▶ Schlüssel 14603		350 889 603	
	▶ Staubkappe		350 889 604	
	▶ Stecksocket		350 889 605	
	▶ Stecksocket		350 889 606	
	▶ Tülle		350 889 607	

Serie 900/9000 Elektrik

	Beschreibung	Referenz	Bestellnummer	Preis €
	<p>Bremslichtschalter M12 x1,5</p> <p>passend für: Serie 900/9000</p>	34-743-001	N601 000	
	<p>Unterbrecherschalter</p> <p>passend für: Serie 900/9000</p>	337 00 71 0023	N602 511	
 	<p>Druckschalter gelb für Arbeitsscheinwerfer</p> <p>passend für: 942, 948, 955, 964, 970</p>	337 0058 0008 1 337 0058 0008	350 872 008	
 	<p>Druckschalter grün für Licht</p> <p>passend für: 942, 948, 955, 964, 970</p>	337 0058 0004 1 337 0058 0004	350 872 004	
	<p>Abstellmagnet MWM</p> <p>passend für: Serie 900/9000</p>	1-40-271 023	N11910	
	<p>Abstellmagnet SISU</p> <p>passend für: 9105, 9115, 9125, 9145</p>	1620 00 09 0704	350 892 704	
	<p>Gebläse</p> <p>passend für: Serie 9000 Komfortkabine</p>		350 211 800	

Serie 900/9000 Beleuchtung

	Beschreibung	Referenz	Bestellnummer	Preis €
	Scheinwerfer Abmessung: 190 x 110 x 100 mm Befestigung: 2 Schrauben Lochabstand 160 mm mit Begrenzungslicht	W186	100 400 186	
ⓔ	<ul style="list-style-type: none"> ▶ Scheinwerferlampe 12V H4 P45t ▶ Kugellampe 12V 4W Ba9s 		091 412 004 091 712 016	
	Hauptscheinwerfer H4 passend für: 9105, 9115, 9125, 9145		N2732	
ⓔ	<ul style="list-style-type: none"> ▶ Scheinwerferlampe 12V H4 P45t ▶ Kugellampe 12V 4W Ba9s 		091 412 004 091 712 016	
	Blink-, Positionsleuchte Links Rechts		100 204 025 100 204 024	
ⓔ	<ul style="list-style-type: none"> ▶ Lichtscheibe steckbar ▶ Kugellampe 12V 21W ▶ Kugellampe 12V 5W 		100 254 004 091 612 010 091 612 014	
	Blink-, Positionsleuchte Links Rechts		100 204 026 100 204 027	
ⓔ	<ul style="list-style-type: none"> ▶ Lichtscheibe schraubbar ▶ Kugellampe 12V 21W ▶ Kugellampe 12V 5W 		100 254 005 091 612 010 091 612 014	
	Schluss-, Brems-, Blinkleuchte Abmessung: 95 x 85 x 54 mm Befestigung: 2 x Ø 5,5 mm Loch Lochabstand: 45mm			
ⓔ	Links Rechts	34-176-061 34-176-060	100 100 112 100 100 107	
	<ul style="list-style-type: none"> ▶ Lichtscheibe steckbar ▶ Kugellampe 12V 21W Ba15s ▶ Kugellampe 12V 10W Ba15s 	34-776-010	100 150 100 091 612 010 091 612 012	

Serie 900/9000 Beleuchtung

	Beschreibung	Referenz	Bestellnummer	Preis €
	Schluss-, Brems-, Blinkleuchte Abmessung: 95 x 85 x 55 mm Befestigung: 2 x Ø 5,5 mm Loch Lochabstand: 45 mm mit/ohne Kennzeichenleuchte durch austauschbare Lichtscheibe			
Ⓔ	Links	34-176-061	100 100 110	
	Rechts	34-176-060	100 100 111	
	▶ Lichtscheibe links schraubbar		100 150 102	
	▶ Lichtscheibe rechts schraubbar		100 150 101	
	▶ Kugellampe 12V 21W Ba15s		091 612 010	
	▶ Kugellampe 12V 10W Ba15s		091 612 012	
	Schluss-, Brems-, Blinkleuchte Abmessung: 140 x 155 mm Befestigung: 4 x PT Schrauben 40 x 20 Schraubenabstand: 110 mm			
Ⓔ	Links mit Kennzeichenbeleuchtung		100 100 108	
	Rechts ohne Kennzeichenbeleuchtung		100 100 109	
	▶ Lichtscheibe links und rechts		100 150 104	
	▶ Kugellampe 12V 21W Ba15s		091 612 010	
	▶ Kugellampe 12V 5W Ba15s		091 612 014	
	Kennzeichenleuchte Steyr CNH JOKON Abmessung: 100 x 55 x 57,5 mm Befestigung: 2 Schrauben M5 Schraubenabstand: 45 mm	34-176-085	100 106 001	
Ⓔ	▶ Kugellampe 12V 5W Ba15s		091 612 014	
	▶ Kugellampe 24V 5W Ba15s		091 624 015	
	Rückstrahler PVC rechteckig Abmessung: 90 x 75 mm Befestigung: Bohrung Ø 5,3mm	34-176-050	100 622 033	
	Arbeitsscheinwerfer Rechts Links	40-179-002 40-179-003	100 500 002 100 500 003 091 312 002	
	▶ Scheinwerferlampe 12V H3 55W Pk22s			
	Befestigungsbügel für Arbeitsscheinwerfer		100 550 014	

Serie 900/9000 Beleuchtung

Beschreibung

Referenz

Bestellnummer



Arbeitsscheinwerfer H3

098 173 590

100 500 500

Abmessung 105 x 105 x 90 mm
Anschluss: 2 x 6,3mm Flachstecker
Befestigung: M10 Schraube, Ω-Bügel u. Gummitülle
Glasstreuscheibe

▶ Scheinwerferlampe 12V H3 55W Pk22s

091 312 002



PowerLEDultra

Arbeitsscheinwerfer LED 1.750 Lumen

12 LED Osram, 11-33V
Anschluss: Kabel 2.500 mm
Befestigung: Ω-Bügel oder Schraube M8
Stromaufnahme: 12V 1,5A / 24V 0,8A
Merkmale: Kunststoffgehäuse

Leuchtkörper komplett vergossen
kein Eindringen von Feuchtigkeit
E-geprüft, funkentstört

100 501 505

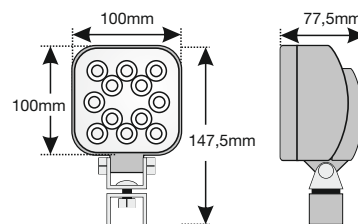

1750
LUMEN



AgriMiniLED

Arbeitsscheinwerfer LED 900 Lumen

4 Epistar LED's
Anschluss: Kabel 450 mm
Befestigung: Schraube M8
Stromaufnahme: 12V 1 A / 24V 0,5 A
Betriebstemp.: -30° bis + 50°C
Merkmale: verpolungsgeschützt, Alu-Gehäuse

Streuscheibe PMMA

100 501 022

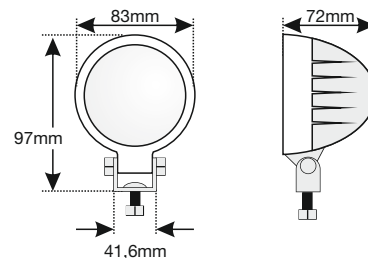

900
LUMEN



Serie 900/9000 Motor

Beschreibung

Referenz

Bestellnummer

Preis €



N0142-KT35



056671

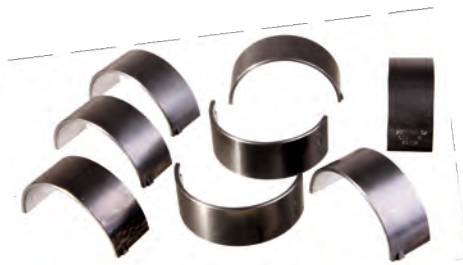

253203OSD

Motor Rep-Satz

3 Zylinder MWM WD301

passend für:
Steyr 955, 964, 968, 970, 975

Set bestehend aus:

Kolben/Büchsen/Satz **3x N0142-KT35**
Pleuellagersatz **3x 500 015 101**
Kopfdichtsatz **3x 500 121 930**

Motor Rep-Satz

4 Zylinder MWM WD401

passend für:
Steyr 9078, 9083, 9086, 9064
Case C78, CS86, CS96

Set bestehend aus:

Kolben/Büchsen/Satz **4x N0142-KT35**
Pleuellagersatz **4x 500 015 101**
Kopfdichtsatz **4x 500 121 930**

Serie 900/9000 Motor

	Beschreibung	Referenz	Bestellnummer	Preis €
	Kolben/Büchsen/Ring-Satz mit 4 O-Ringe passend für: MWM WD301/401		N0142-KT35	
	O-Ring 1,5 mm 4,0 mm passend für: MWM WD301/401		500 017 013 500 017 014	
	Entrußersatz mit Kopfdichtung passend für: MWM WD301/401		500 121 930	
	Pleuellagerpaar passend für: MWM WD301/401		500 015 101	
	Hauptlagerpaar standard passend für: 975 MWM Motor		500 016 002	
	Zylinderkopf komplett für M14 Schrauben mit Federn und Ventile passend für: 942, 948	1311 00 04 0003 1311 00 04 0023 1307 040601 308 00 04 0015 1308 00 04 0014	520 020 902	
	Zylinderkopfschraube M14 passend für: 942, 948	311 00 04 0017	N0159	

Serie 900/9000

Motor

Beschreibung	Referenz	Bestellnummer	Preis €
--------------	----------	---------------	---------

Pleuelschraube

301 0003 0707

500 015 707



passend für:
Serie 900/9000
mit MWM Motor

Einlassventil

311 00 05 0014
1311 00 05 0014

500 014 005

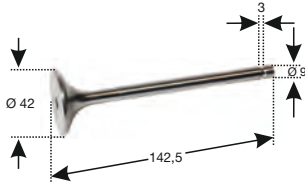

passend für:
942

Auslassventil

311 00 05 0015
1 311 00 05 0015

500 014 006

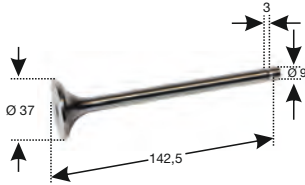

passend für:
942

Einlassventil

611 6005 0001

500 014 007

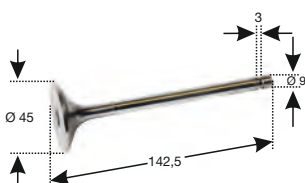

35°
passend für:
948

Auslassventil

611 6005 0002

500 014 008

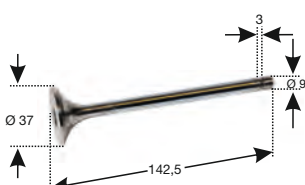

45°
passend für:
948

Stößel

609 05 0002

500 114 001

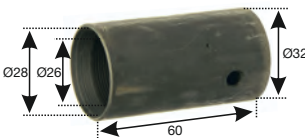

passend für:
942, 948

Zahnkranz

610 00 02 0021
1610 00 02 0021

526 006 014





passend für:
942, 948

Serie 900/9000



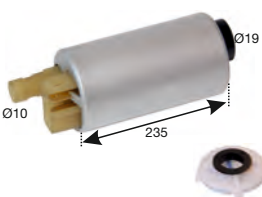

Motor/Diesel

	Beschreibung	Referenz	Bestellnummer	Preis €
	Zahnkranz SISU 128 Zähne passend für: M968, M975, M9078, M9086, M9094 9080M/MT, 9085MT, 9090M/MT, 9095MT 9100M/MT, 9105, 9105MT, 9115, 9125, 9145	132 00 002 0703	520 006 001	
	Turbolader passend für: MWM 3 Zylinder	1301 82 11 0728 1301 82 11 0732	500 024 732	
	Turbolader passend für: MWM 4 Zylinder	1401 00 11 0706	500 024 706	
	Einspritzdüse MWM Motor passend für: 955, 9094, M9094	1301 42 08 0703 0 433 271 691 DLLA152S1180	038 326 691	
	Einspritzdüse MWM Motor passend für: 964, 970, 9078, 9086 M975, M968, M9078, M9086	1301 82 08 0701 0 433 271 790 DLLA151S972	038 326 790	
	Einspritzdüse SISU Motor passend für: 9090MT, 9080MT, 9085MT, 9095MT, 9100MT, 9105MT 9080M, 9090M, 9100M M975, M9094,, M9086	1420 00 08 0703 DLLA152M34359	038 326 003	

Serie 900/9000 Diesel/Filter

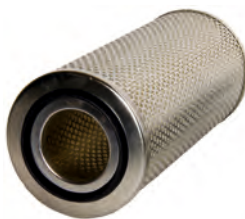
	Beschreibung	Referenz	Bestellnummer	Preis €
	<p>Membranförderpumpe für MWM Motor</p> <p>passend für: 955, 964, 970, M968, M970 9078, 9086, 9094 M9078, M9083, M9086, M9094</p>	<p>1401 00 08 0702 1401 00 08 0709</p>	<p>032 100 550</p>	
	<p>Kraftstoffpumpe</p> <p>passend für: Serie 900</p>		<p>135 100 223</p>	
	<p>Dieselfilter</p> <p>passend für: 900/9000</p>		<p>N702 796</p>	
	<p>Ringnippel</p> <p>passend für: Serie 900/9000</p>	<p>1990 14 23 0017</p>	<p>135 280 017</p>	

Filter

	<p>Luftfilter </p> <p>passend für: Modelle mit MWM Motor bis Baujahr 1998</p>	<p>611 00 19 0028</p>	<p>C17225/3</p>	
	<p>Sicherheitspatrone </p> <p>für N705253</p> <p>passend für: Modelle mit MWM Motor bis Baujahr 1998</p>	<p>611 00 19 0020</p>	<p>CF800</p>	

Serie 900/9000

Kühlung/Kupplung

Beschreibung	Referenz	Bestellnummer	Preis €
--------------	----------	---------------	---------



Wasserpumpe
MWM Motor

301 00 06 0703

500 012 008

passend für:
900/9000



Ringnippel

1990 14 23 0017

135 280 017

passend für:
900/9000

Kupplung

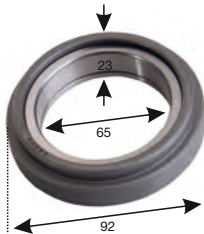

Drucklager
für Fahrkupplung

337 00 21 0065
1337 00 21 0065

Drucklager Sachs
Drucklager



520 003 004
520 003 701

passend für:
942, 948, 955, 964, 970, 968, 975
M948, M952, M958, M963, M968, M975
M9078, M9083, M9086, M9094
9078, 9086, 9094, 9080M, 9090M
9100M

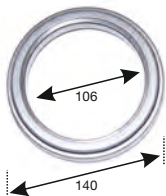

Drucklager
für Zapfwelle

337 00 21 0066

520 003 702

passend für:
942, 948, 955, 964, 970, 968, 975
M948, M952, M958, M963, M968,
M975
M9078, M9083, M9086, M9094
9078, 9086, 9094, 9080M, 9090M
9100M

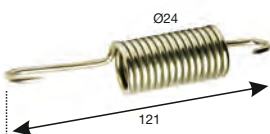

Kupplungsfeder

1680230008

N1053

passend für:
Serie 900/9000

Serie 900/9000

Kupplungssteuerung/Getriebe

Beschreibung	Referenz	Bestellnummer	Preis €
--------------	----------	---------------	---------

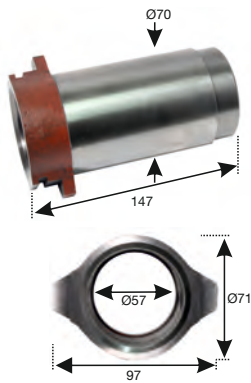

Ausrückhülse

1337 00 21 0063

520 004 063

passend für:
 942, 948, 955, 964, 970
 M948, M952, M958, M963, M968, M975
 M9078, M9083, M9086, M9094
 9078, 9086, 9086
 9080M, 9090M, 9100M

Getriebe

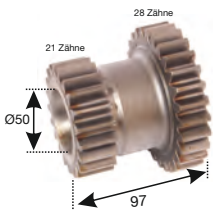

Doppelstirnrad

337 00 27 0078

520 007 003

1337 00 027 0078

passend für:
 942, 948, 955, 964, 970
 M948, M952, M958, M963, M968, M975
 M9078, M9083, M9086, M9094
 9078, 9086, 9094
 9080M, 9090M, 9100M
 9080MT, 9085MT, 9090MT, 9095MT
 9100MT, 9105MT

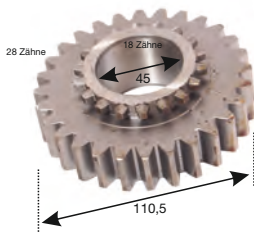

Gegenstirnrad

337 0027 0080

520 007 004

1337 0027 0080

passend für:
 942, 948, 955, 964, 970
 M948, M952, M958, M963, M968,
 M975
 M9078, M9083, M9086, M9094
 9078, 9086, 9094
 9080M, 9090M, 9100M
 9080MT, 9085MT, 9090MT, 9095MT
 9100MT, 9105MT

Serie 900/9000

Hinterachse/Antrieb

	Beschreibung	Referenz	Bestellnummer	Preis €
	Hinterachswelle passend für: 942, 948	317 003 20015 1 317 003 20015	522 100 009	
	Bremsgehäuse links rechts passend für: 955, 964, 970	1295 330020 1295 330022	524 214 020 524 214 022	
	Bremsgehäuse links rechts passend für: 942, 948 alte Ausführung nicht M	317 0033 0009 317 0033 0010	524 214 009 524 214 010	
	Zahnkranz für Hinterachse passend für: 964, 968, 970, 975 bis Baujahr 2004	337 00 32 0060 1337 00 32 0060	522 400 060	
	Planetenrad passend für: 964, 968, 970, 975 bis Baujahr 2004 9078, 9086, 9094 bis Baujahr 2003	337 00 32 0058 1337 00 32 0058	522 400 058	
	Bolzen passend für: 964, 970, M968 9078, 9086, 9094	337 00 32 0063 1337 00 32 0063	522 400 063	
	Nadellager passend für: 964, 970 M968, M975 9078, 9086, 9094	337 00 32 0061 1337 00 32 0061	522 400 061	

Serie 900/9000

Hinterachse/Antrieb

Beschreibung	Referenz	Bestellnummer	Preis €
--------------	----------	---------------	---------



Schauglasverschraubung
Hinterachse

337 00 32 0058
1337 00 32 0058

522 006 910

passend für:
9080M, 9090M, 9100M
9080MT, 9085MT, 9090MT, 9095MT
9100MT, 9105MT
M9078, M9086, M9094

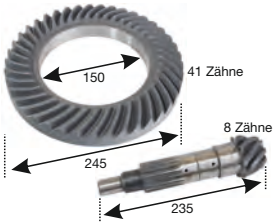

Tellerrad und Ritzel
verbesserte Ausführung
mit Schmierloch

337 0032 0079
337 0032 0158
337 0032 0219
1 337 0032 0158
1 337 0032 0219

522 100 603

passend für:
942, 948, 955, 964, 970
M968, M975

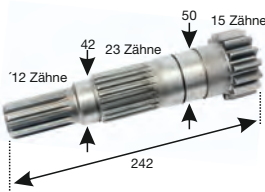

Ritzelachse

317 00 32 0001

522 400 001

passend für:
942, 948

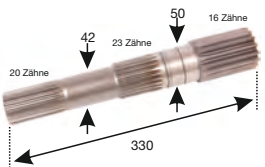

Ritzelachse

295 32 0020

522 400 020

passend für:
964, 970

Serie 900/9000

Bremse

Beschreibung	Referenz	Bestellnummer	Preis €
 <p>Bremssacke</p> <p>passend für: 942, 948</p>	317 00 34 0008 317 00 34 0014 1317 00 34 0014	524 200 014	
 <p>Bremssacke</p> <p>passend für: 955, 964, 970</p> <p>Belagbreite 60</p>	337 00 34 0914 1337 00 34 0914	524 200 914	
 <p>Bremstrommel</p> <p>passend für: 942, 948</p>	317 00 34 0001 1317 00 34 0001	524 100 032	
 <p>Bremstrommel feine Verzahnung (23 Zähne)</p> <p>passend für: 955, 964, 970 (MWM) CASE CS55-CS70</p>	295 34 0031 1295 34 0031	524 100 031	<p>i Nur mit mechanischer Bremse!</p>
 <p>Hauptbremszylinder Originalqualität Bremskolben ca 19 mm</p> <p>passend für: M948, M952, M958, M963, M968, M975</p>	1-33-135-417	524 216 417	
 <p>Hauptbremszylinder Originalqualität Bremskolben ca 22 mm</p> <p>passend für: 9080M/MT, 9085MT, 9090M/MT, 9095MT 9100M/MT, 9105MT, 9105, 9115, 9125, 9145</p>	1-33-135-418	524 216 418	
 <p>Bremsfeder</p> <p>passend für: 948, 955, 970 mit trockener Bremse</p>	288 34 0042 1288 34 0042	N2008	

Serie 900/9000

Bremse/Lenkung

Beschreibung	Referenz	Bestellnummer	Preis €
--------------	----------	---------------	---------

Ringnippel

1990 14 23 0017

135 280 017



passend für:
Serie 900/900

Lenkung

Lenkrad

33-147-270

N2075-6



passend für:
Serie 900/9000

Abdeckkappe

92 47 0003

N92470003

für Lenkrad N2075-6



Gelenkkopf M24 x 1,5

377 0047 0066

522 300 001

377 0047 0109

377 0047 0114

377 0047 0144

1377 0047 0066

1377 0047 0109

1377 0047 0114

1377 0047 0144

passend für:
942, 948, 955, 964, 970
M948, M952, M958, M963, M975
9078, 9086, 9094
M9078, M9083, M9086, M9094

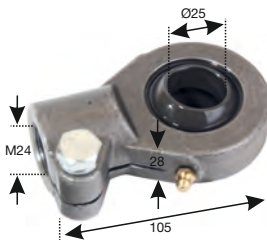

Dichtring

377 0047 0103

522 300 103

für Gelenkkopf 522 300 001

1377 0047 0103

passend für:
942, 948, 955, 964, 970
M948, M952, M958, M963, M975
9078, 9086, 9094
M9078, M9083, M9086, M9094

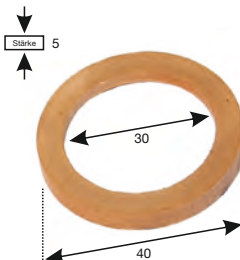

Serie 900/9000

Achse

Beschreibung

Referenz

Bestellnummer

Preis €

Lagerbock

317 0041 0002

522 100 037

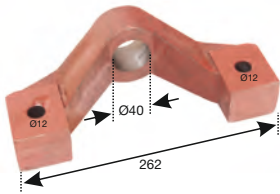

passend für:
942, 948

Lagerbock

317 0041 0004

522 100 038

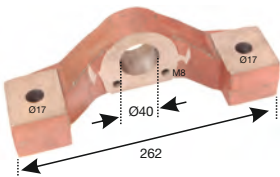

passend für:
942, 948

Achsschenkel links

337 0041 0247

522 100 033

für starre Achse

1 337 0041 0247

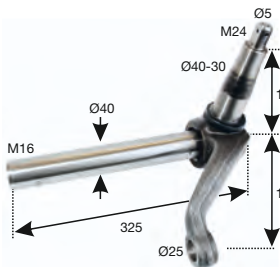

passend für:
942, 948, 955, 964

M948, M952, M958, M963, M968, M9078
9078, 9086

Achsschenkel rechts

337 0041 0245

522 100 034

für starre Achse

1 337 0041 0245

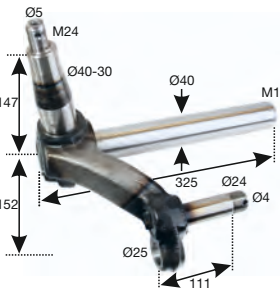

passend für:
942, 948, 955, 964

M948, M952, M958, M963, M968, M9078
9078, 9086

Serie 900/9000 Allrad

Beschreibung	Referenz	Bestellnummer	Preis €
--------------	----------	---------------	---------

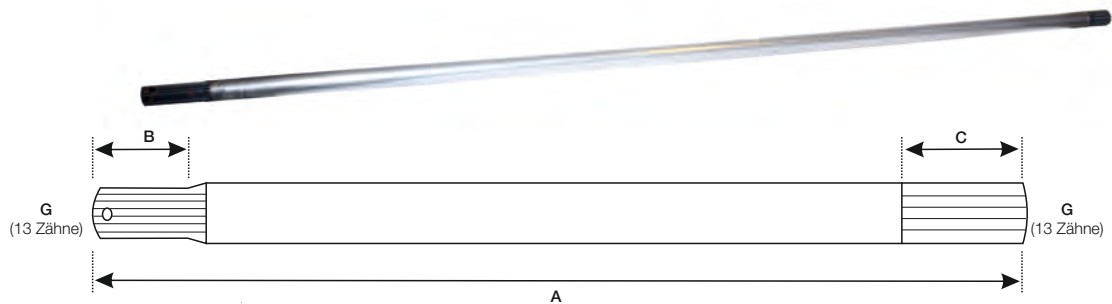

Antriebswelle für Vorderachse Allrad

passend für:	A	B	C	Modul vorne	Modul hinten	
955, 964, 970, 975	1550 mm	85 mm	75 mm	G	G	522 401 006
Serie 9000 mit 4 Zyl-Motor	1605 mm	85 mm	75 mm	G	G	522 401 007
	1710 mm	85 mm	170 mm	G	G	522 401 008**

** Universalachse C auf gewünschte Gesamtlänge zu kürzen

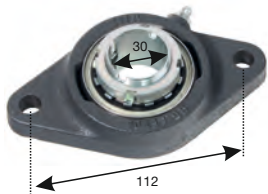

Flansch
mit Gehäusehalterung und Lager

357 00 31 0015
1357 00 031 0015

522 100 015

passend für:
942, 948

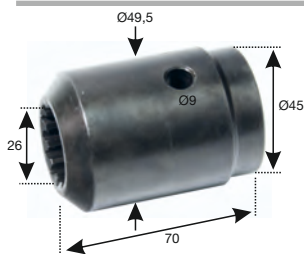

Muffe
hinten für Verschleißwelle Allrad
13 Zähne

337 00 29 0258
1337 00 29 0258

522 100 258

passend für:
942, 948, 955, 96, 970
M948, M952, M958, M963, M968, M975
M9078, M9083, M9086, M9094
9078, 9086, 9094
9080M/MT, 9085MT, 9090 M/MT, 9095MT
9100M/MT, 9100MT, 9105MT

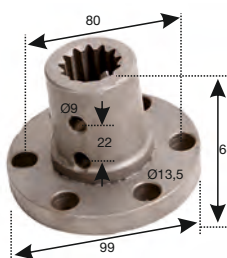

Allradflansch
6-Loch

1-33-131-006

522 100 039

passend für:
Serie 900

Serie 900/9000

Hydraulik

Beschreibung	Referenz	Bestellnummer	Preis €
	Hydraulikpumpe	0 510 665 335	521 010 009
passend für: Steyr 955, 964, 9078, 9086, 9094 Case C55, C64, C70, CS 78, CS 86 CS 94			
	Anlenkblock	292 73 0051 1292 73 0051	522 200 051
passend für: Serie M900 - 942, 948, 955, 964, 970,975 Serie M9000			
	Hubstrebe	32 274 010	522 200 064
passend für: Serie 900			
	Unterlenkbolzen 40KN für Regelhydraulik		521 020 058
passend für: Serie 900/9000 mit EHR (Eelekt. Hubwerk Regelung)			
	Schauglasverschraubung Hydraulik	337 00 32 0058 1337 00 32 0058	522 400 058
passend für: 9080M, 9090M, 9100M 9080MT, 9085MT, 9090MT, 9095MT 9100MT, 9105MT M9078, M9086, M9094			
	Ackerschiene	337 00 74 0051 1337 00 74 0051	522 200 004
passend für: 942, 948, 955, 964, 970 M948, M952, M958, M963, M968, M975			

Serie 900/9000

Klima

Beschreibung

Referenz

Bestellnummer

Preis €



Klimakompressor
für Seltec TM16HD
Riemenscheiben Ø 135 mm

470 100 430

passend für:
M968, M975,
M9078, M9083, M9086, M9094
9105, 9115, 9125, 9155



Klimakompressor
für Sanden SD7H15HD
Riemenscheiben Ø 152 mm

470 100 462

passend für:
9105, 9115, 9125, 9145, 9155

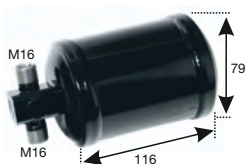

Klimatrockner

470 102 168

passend für:
M968, M975
M9078, M9080, M9083, M9096,
M9094

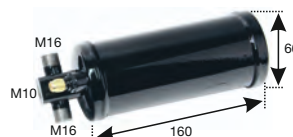

Klimatrockner

470 102 076

passend für:
9105, 9115, 9125, 9145
M9078, M9086, M9094

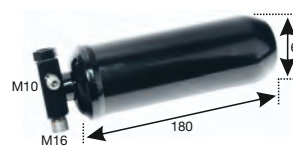

Klimatrockner

470 102 615

passend für:
MT9080, MT9085, MT9090, MT9095
Mt9100, MT9105

Serie 900/9000

Karosserie

Beschreibung	Referenz	Bestellnummer	Preis €
--------------	----------	---------------	---------



Spiegel

34-377-017

N729 254

▶ Spiegelglas

34-777-042

N722 451

passend für:
Serie 900/9000

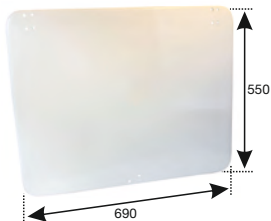

Sonnendach für 3 Versionen

34 519 372
1 34 519 372

523 100 032

passend für:
900-9000



Innenverkleidung 3-teilig klein

grau 10 mm Stärke
Heckabschlussblech, Kotflügel
rechts und links

523 100 038

passend für:
942 bis 958



Innenverkleidung 3-teilig groß

grau 10 mm Stärke
Heckabschlussblech, Kotflügel
rechts und links

523 100 037

passend für:
964 bis 975



Heckabschlussblech

neue Version,

1 34-703-128

1 34-703-173

ohne Scheibe
mit Scheibe
aus Kunststoff bruchfest, vergilbt nicht

523 100 033

523 100 034

passend für:
948 bis 975

Serie 900/9000

Karosserie

Beschreibung

Referenz

Bestellnummer

Preis €

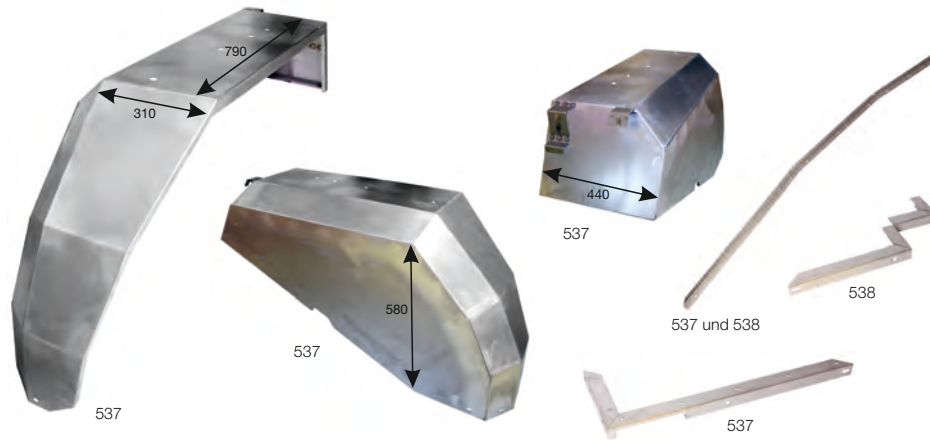

Kotflügel hinten unlackiert
2 mm Stärke (Original 1,8 mm)
aus einem Teil gefertigt
inkl. Anbauteile

links
rechts

523 140 537
523 140 538

passend für:
942, 948, 958

i ACHTUNG:
Versandkosten-Pauschale!

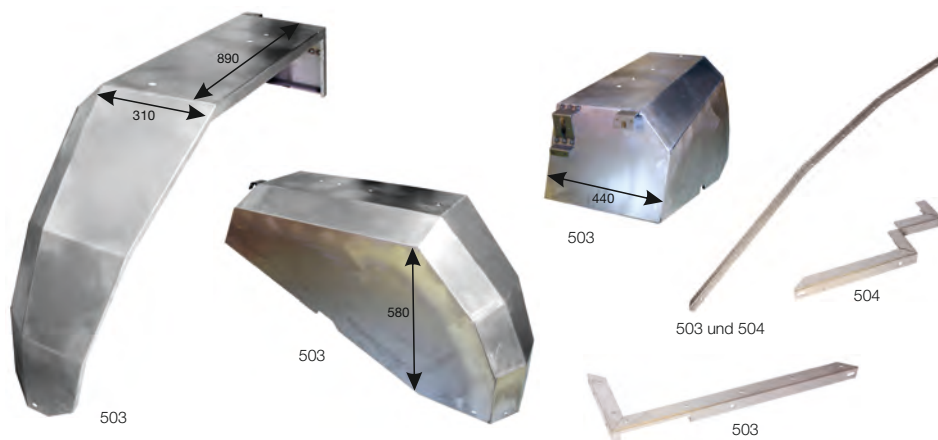

Kotflügel hinten unlackiert
2 mm Stärke (Original 1,8 mm)
aus einem Teil gefertigt
inkl. Anbauteile

links
rechts

1-34-525-207/620 **523 140 503**
1-34-525-206/600 **523 140 504**

passend für:
955, 964, 968, 975
M968, M975

i ACHTUNG:
Versandkosten-Pauschale!



Beschreibung	Referenz	Bestellnummer	Preis €
--------------	----------	---------------	---------



Alternator

MAGENTON OE	14V 95A		N390112
MAGENTON OE	14V 120A		N390122

passend für:

CVT120	SISU	2000-2003
CVT130	SISU Turbo	2000-2003
CVT150	SISU Turbo	2000-2003
CVT170	SISU Turbo	2000-2003
CVT6135	SISU Turbo	2000-2003
CVT6140	SISU Turbo	2007
CVT6145	SISU Turbo	2003-2006
CVT6150	SISU Turbo	2007
CVT6155	SISU Turbo	2003-2006
CVT6160	SISU Turbo	2007
CVT6170	SISU Turbo	2003-2006
CVT6175	SISU Turbo	2007
CVT6190	SISU Turbo	2003-2005
CVT6195	SISU Turbo	2006



Alternator

LETRIKA (Iskra) 14V 150A	84141453	IA1378
LETRIKA (Iskra) 14V 200A	84141454	IA1379

passend für:

CVT6130	2010-	87708178
CVT6145	2010-	
CVT6160	2010-	
CVT6200	2010-	



Alternator

LETRIKA (Iskra) 14V 150A	84141455	IA1198
LETRIKA (Iskra) 14V 200A	84141456	IA1301

passend für:

CVT6170	2010-	
CVT6180		
CVT6190	FPT	
CVT6195	FPT	
CVT6200	FPT	
CVT6205	FPT	
CVT6210		
CVT6215		
CVT6225		
CVT6230		

Beschreibung	Referenz	Bestellnummer	Preis €																																										
 <p>Starter</p> <p>LETRIKA (Iskra) 12V 3,2 KW 11Z LETRIKA (Iskra) 12V 4,2 KW 11Z Getriebeausführung passend für:</p> <table border="0"> <tr><td>CVT120</td><td>SISU</td><td>2000-2003</td></tr> <tr><td>CVT130</td><td>SISU Turbo</td><td>2000-2003</td></tr> <tr><td>CVT150</td><td>SISU Turbo</td><td>2000-2003</td></tr> <tr><td>CVT170</td><td>SISU Turbo</td><td>2000-2003</td></tr> <tr><td>CVT6135</td><td>SISU Turbo</td><td>2000-2003</td></tr> <tr><td>CVT6140</td><td>SISU Turbo</td><td>2007</td></tr> <tr><td>CVT6145</td><td>SISU Turbo</td><td>2003-2006</td></tr> <tr><td>CVT6150</td><td>SISU Turbo</td><td>2007</td></tr> <tr><td>CVT6155</td><td>SISU Turbo</td><td>2003-2006</td></tr> <tr><td>CVT6160</td><td>SISU Turbo</td><td>2007</td></tr> <tr><td>CVT6170</td><td>SISU Turbo</td><td>2003-2006</td></tr> <tr><td>CVT6175</td><td>SISU Turbo</td><td>2007</td></tr> <tr><td>CVT6190</td><td>SISU Turbo</td><td>2003-2005</td></tr> <tr><td>CVT6195</td><td>SISU Turbo</td><td>2006</td></tr> </table>	CVT120	SISU	2000-2003	CVT130	SISU Turbo	2000-2003	CVT150	SISU Turbo	2000-2003	CVT170	SISU Turbo	2000-2003	CVT6135	SISU Turbo	2000-2003	CVT6140	SISU Turbo	2007	CVT6145	SISU Turbo	2003-2006	CVT6150	SISU Turbo	2007	CVT6155	SISU Turbo	2003-2006	CVT6160	SISU Turbo	2007	CVT6170	SISU Turbo	2003-2006	CVT6175	SISU Turbo	2007	CVT6190	SISU Turbo	2003-2005	CVT6195	SISU Turbo	2006	47111575	IS0897 IS0836	
CVT120	SISU	2000-2003																																											
CVT130	SISU Turbo	2000-2003																																											
CVT150	SISU Turbo	2000-2003																																											
CVT170	SISU Turbo	2000-2003																																											
CVT6135	SISU Turbo	2000-2003																																											
CVT6140	SISU Turbo	2007																																											
CVT6145	SISU Turbo	2003-2006																																											
CVT6150	SISU Turbo	2007																																											
CVT6155	SISU Turbo	2003-2006																																											
CVT6160	SISU Turbo	2007																																											
CVT6170	SISU Turbo	2003-2006																																											
CVT6175	SISU Turbo	2007																																											
CVT6190	SISU Turbo	2003-2005																																											
CVT6195	SISU Turbo	2006																																											
 <p>Starter</p> <p>LETRIKA (Iskra) 12V 4,2 KW 10Z Getriebeausführung passend für:</p> <table border="0"> <tr><td>CVT6180</td><td>FPT</td><td>2009</td></tr> <tr><td>CVT6200</td><td>FPT</td><td></td></tr> <tr><td>CVT6210</td><td>FPT</td><td></td></tr> <tr><td>CVT6225</td><td>FPT</td><td>2009</td></tr> </table>	CVT6180	FPT	2009	CVT6200	FPT		CVT6210	FPT		CVT6225	FPT	2009	82032859 82039052 84151331 87318375 87653219	IS0999																															
CVT6180	FPT	2009																																											
CVT6200	FPT																																												
CVT6210	FPT																																												
CVT6225	FPT	2009																																											
 <p>Hauptschalter</p> <p>passend für: CVT Case: CVX</p>	82022881	350 882 881																																											
 <p>Schalteinheit</p> <p>passend für: CVT</p>		350 890 054																																											
 <p>Relais</p> <p>passend für: CVT</p>	1-40-258-111 84543528	WE29 201 075A																																											

Beschreibung

Referenz

Bestellnummer

Preis €



Klimakompressor
für Sanden SD7H15HD
Riemenscheiben Ø 152 mm

passend für:
CVT120, 130, 150
CVT6135, 6145, 6155, 6170, 6190

470 100 462



Klimakompressor
für Sanden SD5H14
Riemenscheiben Ø 132 mm

passend für:
CVT6140, 6150, 6175, 6195

470 100 185

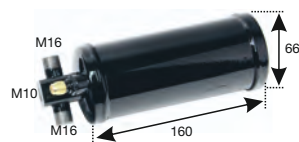

Klimatrockner

passend für:
CVT120, 130, 150, 170
CVT6155, 6170, 6190

470 102 076

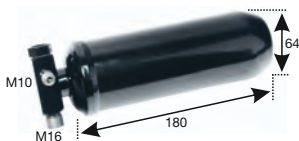

Klimatrockner

passend für:
CVT6140, 6150, 6160, 6175, 61,95

470 102 615



Klimatrockner

passend für:
CVT 6115, 6125, 6130, 6145, 6160
CVT 6165, 6170, 6180, 6185
CVT 6200, 6205, 6210, 6215, 6225, 6230

470 102 822

CVT/Profi

Diverses

Beschreibung	Referenz	Bestellnummer	Preis €
 Zahnkranz SISU 128 Zähne passend für: CVT120, 130, 150, 170 CVT6135, 6140, 6145, 6150, 6155, 6160 CVT6170, 6175, 6190, 6195	132 00 002 0703	520 006 001	

 Einspritzdüse SISU Motor passend für: CVT 120, 130, 150, 170 CVT6135, 6145, 6155, 6170, 6190	1620 00 08 0867 DLLA152M35926	038 326 926	
---	----------------------------------	--------------------	--

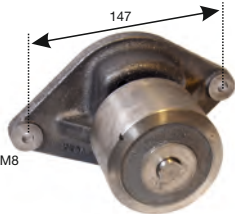
 Wasserpumpe für FPT Motor (Fiat Power Train) passend für: CVT: 6165, 6180, 6200, 6210, 6225	2854835	500 012 016	
--	---------	--------------------	--

Karosserie

 Kabinenfederdämpfer passend für: CVT 120, 130, 150, 170, 6135, CVT 6145, 6155, 6170, 6190	1 34 641 646 1 34 641 650	523 100 105	
---	------------------------------	--------------------	--

PROFI

Elektrik

 Alternator Iskra 14V/120 Ampere 14V 150 Ampere passend für: 4100 03-07 4110 4115 03-07 4120 07-09 4130 07-09 6115 03-09 6125 03-09 6135 03-07 6140 03-09	87361082 82020011 84141452 87310882 87652087	201 250 017 IA1378	
---	--	-------------------------------------	--

Beschreibung	Referenz	Bestellnummer	Preis €
 <p>Starter Profi</p> <p>LETRIKA (Iskra) 12V 4,2 KW 10Z Getriebeausführung</p> <p>passend für: 4100 4110 4115 4120 4130 6115 6125 6135 6140</p>	82032859	IS0999	
	82039052		
	84151331		
	87318375		
	87653219		

Kühlung

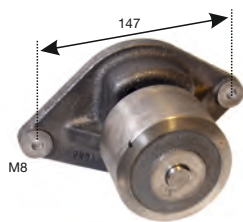

Wasserpumpe
für FPT Motor (Fiat Power Train)

2854835

500 012 016

passend für:
Profi

Karosserie



Spiegel

5-126-233

N5126233

passend für:
Profi



Klimakompressor
für Sanden SD7H15
Riemenscheiben 4PK Ø 112

470 100 912

passend für:
4100, 4110, 4115, 4120, 4130
6115, 6125, 6135, 6140







Klimatrockner
TIER 3

470 102 822

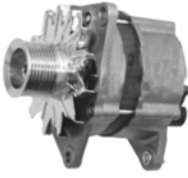
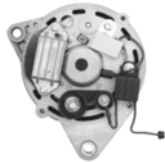
passend für:
4110, 4120, 4130
6115, 6125, 6140

Kompakt Diverses

Beschreibung	Referenz	Bestellnummer	Preis €
Alternator Kompakt			
	LETRIKA (Iskra) 14V 120A	IA1504	
	passend für:		
	360	2004-2008	
	370	2004-2008	
	375	2004-2008	
	485		
	495		
	4055		
	4075		
	4085		
	4095		
			
<hr/>			
Starter Kompakt			
	UMLAUFF 12V 2,7 KW 9Z	18100203	
	LETRIKA (Iskra) 12V 2,6 KW 9Z	IS1263	
	Getriebeausführung		
IS0203			
	passend für:		
	360	2004-2008	
	370	2004-2008	
	375	2004-2008	
			
IS1263			
<hr/>			
Starter Kompakt			
	LETRIKA (Iskra) 12V 4,2 KW 10Z	842089903	
	Getriebeausführung	842089803	
	passend für:		
	485		
	495		
	4065		
	7075		
	4085		
	4095		

Karosserie



Spiegel

5-126-233

N5126233

passend für:
Kompakt

Beschreibung

Referenz

Bestellnummer

Preis €



Klimakompressor
für Sanden SD5H14
Riemenscheiben Ø 132 mm

passend für:
360, 370, 375, 485, 495

470 100 185

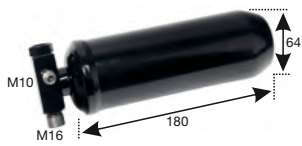







Klimatrockner

passend für:
360, 370, 375, 485, 495,
4065S, 4055S

470 102 615



	Beschreibung	Referenz	Bestellnummer	Preis €
	Lichtmaschine 11A	LRD 101	N395 100	
	Lichtmaschine 22A	LRD 100	N393 007	
	Regler 11A	NCB 118	210 213 118	
	Regler 11A	NCB 119	210 213 119	
	Regler 11A	NCB 134	210 213 134	
	Regler 20A	NCB 130	210 213 130	
	Alternator 14V 34A Lucas ▶ Anschlussstecker	LRA 100	N393 169 345 003 001	

	Beschreibung	Referenz	Bestellnummer	Preis €
	<p>Alternator 14V 34A Iskra mit 9,5 mm Riemenscheibe</p> <p>▶ Anschlussstecker</p>	LRA 100	<p>IA0067</p> <p>345 003 001</p>	
	<p>Riemenscheibe 12,5 mm</p>		N380 807	
	<p>Alternator mit 12,5 mm Riemenscheibe</p> <p>55 Ampere 70 Ampere</p> <p>▶ Anschlussstecker</p>		<p>N390 396 201 210 005</p> <p>345 003 001</p>	
	<p>Starter 12V 2,0 KW 10Z</p> <p>passend für: 3 Zylinder Perkinsmotor</p>		LRS 190	
	<p>Starter 12V 1,8 KW 10Z ISKRA</p> <p>passend für: 3 Zylinder Perkinsmotor</p>		IS0711	
	<p>Starter 12V 2,8 KW 10Z</p> <p>passend für: 4 Zylinder Perkinsmotor</p>		LRS 306	
	<p>Flammglühkerze</p>	154GK	N404 154	

	Beschreibung	Referenz	Bestellnummer	Preis €
	Zündschloss 6 Anschlüsse Lucas alte Version	34 228 128SA	350 883 229	
	▶ Ersatzschlüssel	54 324 157	350 889 157	
	Zündschloss 7 Anschlüsse Lucas neue Version		350 883 230	
	▶ Ersatzschlüssel passend für: GEO Serie		350 889 157	
	Zündschloss COBO		350 885 020	
	▶ Ersatzschlüssel		350 889 988	
	Licht-Drehschalter mit Horn		350 886 107	
	Lenkstockschalter		350 881 004	
	passend für: z.B. für GEO			
	Wippschalter COBO		350 896 032	

Beschreibung	Referenz	Bestellnummer	Preis €
--------------	----------	---------------	---------



Scheinwerfereinsatz
Abmessung: Ø 105 mm

100 400 053

passend für:
alte Lindner Traktoren



Scheinwerfer
Abmessung: 140 x 140 x 112 mm
Befestigung: Klammern
schräger Steg

100 400 120

Ⓔ

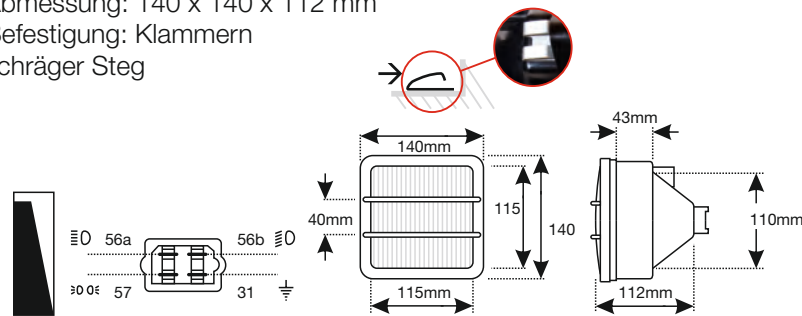

- ▶ Scheinwerferglas
- ▶ Einbaurahmen
- ▶ Dichtung
- ▶ Scheinwerferlampe 12V 45/40W P45t
- ▶ Kugellampe 12V 4W Ba9s

100 450 120
100 550 007
100 550 008
091 512 006
091 712 016

Blink-, Positionsleuchte

100 204 020

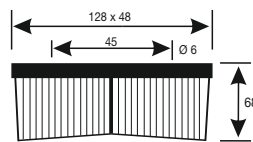

- ▶ Lichtscheibe
- ▶ Sockel für geneigten Anbau

100 254 020
100 550 001



- ▶ Soffittenlampe 12V 18W S8,5 41mm
- ▶ Soffittenlampe 12V 5W S8,5 36mm

091 812 031
091 812 026

Schluss-, Brems-, Blinkleuchte
128 x 68 x 48 mm, Schraubenabstand: 45 mm



Links
Rechts

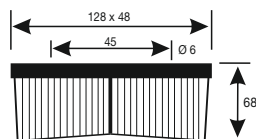

- ▶ Lichtscheibe links
- ▶ Lichtscheibe rechts
- ▶ Sockel für geneigten Anbau





100 100 084
100 100 085







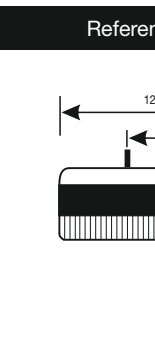
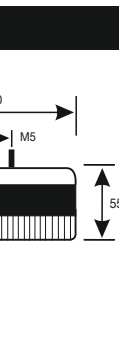



- ▶ Soffittenlampe 12V 18W S8,5 41 mm
- ▶ Soffittenlampe 12V 5W S8,5 36 mm







091 812 031
091 812 026

Lindner Beleuchtung/Diesel

Beschreibung	Referenz	Bestellnummer	Preis €
 <p>Blink-, Begrenzungsleuchte</p> <p>passend für: GEO</p> <ul style="list-style-type: none"> ▶ Lichtscheibe schraubbar ▶ Kugellampe 12V 21W ▶ Kugellampe 12V 5W 		<p>100 204 028</p> <p>100 254 006</p> <p>091 612 010</p> <p>091 612 014</p>	
 <p>Einspritzpumpen Rep-Satz für DPA Pumpe</p>	7135-110	135 011 110	
 <p>Deckeldichtung für DPA Pumpe</p>	7123-287	135 010 205	
 <p>Verstellwelle</p> <p>O-Ring</p> <p>für DPA Pumpe</p>		135 251 770	135 010 491
 <p>Einspritzdüse</p> <p>passend für: F450, 520 1048, 1450, 1500</p>	5621-649 BDLL150S6602	038 326 649	

	Beschreibung	Referenz	Bestellnummer	Preis €
	Einspritzdüse passend für: BF620		038 326 696	
	Düsendichtring		135 751 401	
	Vorreiniger Perkins		135 172 801	
	Dichtung		135 010 805	
	Sieb (Bohrung mittig)		135 172 220	
	Dieselfilter CAV	7111-296	N707 296	
	Filterschauglas	7111-429	135 280 429	
	Förderpumpe 2-Loch Flansch passend für: MF 253, Landini 5500 Perkins Motor 3.152		135 100 184	
	Förderpumpe 4-Loch Flansch passend für: Perkins Motor 4.236/4.248		135 100 025	

Linder Diverses

	Beschreibung	Referenz	Bestellnummer	Preis €
	Luftfilter passend für: BF 620, 1048, 1055, 1065 BF 1450-1700	C14 179	N705 933	
	Luftfilter passend für: GEO	C15 300	C15 300	
Kühlung				
	Kühlerschlauch	5150001004	N0297	
Karosserie				
	Spiegel ► Spiegelglas passend für: GEO Modelle		N729 254 N722 451	
Bremse				
	Radbremszylinder Originalhersteller	7 337 0034 0034	524 215 535	
	Hauptbremszylinder Originalhersteller passend für: 1600, 1650, 1700, 1750	3000754	524 216 754	

	Beschreibung	Referenz	Bestellnummer	Preis €
	Hydraulikzylinder	7288730060	521 020 060	
	Hydraulikkolben	7288730066	521 020 001	
	Anlenkbock passend für: Bf520, 670, 1048, 1055, 1065 1450-1750 GEO 50-93	7292730051	522 200 051	
	Schauglasverschraubung	7397210072	520 006 910	
	Hubstrebe passend für: GEO Serie		522 200 064	
 <p>Ø10 113</p>	Bolzen für Hubstrebe N76064		522 200 105	
	Endzusatz-Steuergerät	028 0073 0010	522 230 010	

Nummernverzeichnis

18540412	100 100 07524	100 254 01020
99014080	100 100 07823	100 254 020212
990140136	100 100 07923	100 256 00221
9901657	100 100 084212	100 400 04016
9902537	100 100 085212	100 400 04116
99025379	100 100 08924	100 400 04217
9906446,79	100 100 09923	100 400 04417
990657136	100 100 10023	100 400 04618
990863136	100 100 101141	100 400 04819
9909716	100 100 102141	100 400 04919
992149135	100 100 103141	100 400 05317, 212
999086480	100 100 104141	100 400 10086
18100203206	100 100 106141	100 400 120212
814680127	100 100 107142, 180	100 400 149140, 168
100 104 01221	100 100 108181	100 400 177140
503 192 83135	100 100 109181	100 400 18018
523 100 01572	100 100 110181	100 400 181140
0 342 316 003137	100 100 111181	100 400 186180
0 343 008 0069	100 100 112142, 180	100 400 84316
0 343 008 0098	100 104 01022	100 450 00817
0 343 401 0018	100 104 01122	100 450 00919
032 100 550187	100 104 01321	100 450 01017
038 226 150151	100 104 01421	100 450 01118, 19
038 275 066100	100 104 01522	100 450 01218, 19
038 326 003186	100 104 01622	100 450 01316
038 326 164100	100 104 01722	100 450 01317
038 326 205100, 150	100 106 001142, 181	100 450 01519
038 326 440100	100 106 00324	100 450 120212
038 326 446150	100 106 00424	100 500 002181
038 326 649213	100 106 00524	100 500 003181
038 326 691186	100 106 01024	100 500 10087, 142
038 326 696214	100 150 07524	100 500 500142, 182
038 326 731151	100 150 07624	100 500 510142
038 326 746150	100 150 084212	100 500 586142
038 326 790186	100 150 085212	100 500 586168
038 326 857150	100 150 08824	100 501 022182
038 326 926204	100 150 09422	100 501 505182
039 305 00143	100 150 09523	100 550 001212
039 305 00943	100 150 096141	100 550 00219
039 305 02743	100 150 097141	100 550 00316, 17
04060-00-008102	100 150 098141	100 550 00417
041 158 176101	100 150 099141	100 550 00522, 23
060 677 02042, 43	100 150 100142	100 550 00617
061 612 014181	100 150 100180	100 550 007212
083 851 90311	100 150 101181	100 550 008212
083 862 8109	100 150 102181	100 550 014181
083 863 00410	100 150 104181	100 550 01518, 19
083 863 03210	100 154 00122	100 550 01617, 19
083 872 01280	100 154 00223	100 550 01718, 19
087 065 9008	100 154 00523	100 550 01875
091 312 00287, 142, 168, 181, 182	100 154 01221	100 550 01921
091 412 00485, 128, 140, 180	100 154 01322	100 550 02018
091 512 00617, 18, 140, 168, 212	100 154 01322	100 550 02116
091 612 00820, 24, 86, 141	100 156 00125	100 550 23716
091 612 01022, 23, 86, 141,	100 201 022141	100 550 23816
.....142, 180, 181, 213		100 204 00220	100 550 25016
091 612 01220, 21, 142, 180, 181	100 204 00320	100 622 00125
091 612 014141, 142, 180, 213	100 204 01020	100 622 00425
091 612 015142	100 204 020212	100 622 033142, 181
091 612 09316, 18, 19	100 204 024141, 180	100 900 04287
091 624 015181	100 204 025141, 180	100 900 70481
091 712 01616, 17, 18, 140, 180, 212	100 204 026180	130 020 31074
091 712 0189	100 204 027180	130 299 00174
091 712 02825, 87	100 204 028213	130 310 08070
091 812 01617	100 206 02020	130 310 08470
091 812 02620, 21, 22, 23, 24, 212	100 206 02120	130 310 18070
091 812 03120, 21, 23, 24, 212	100 206 02221	130 310 18170
091 812 03520, 22, 24	100 208 00125	130 310 18870
091 812 06622	100 208 00225	130 310 19070
091 812 70025	100 208 00325	130 311 00170
093 199 20260	100 208 00425	130 311 00270
093 210 00183	100 208 00525	130 320 00169
093 210 00383	100 208 00625	130 330 08471
093 230 04583	100 208 00725	130 330 18071
093 257 36083	100 208 00825	130 330 18871
093 257 40083	100 208 01325	135 010 00146
097 101 175134	100 208 01425	135 010 00337
097 101 2006, 78	100 254 00220	135 010 00443
097 101 2756, 78	100 254 003141	135 010 00737
097 101 32578, 134	100 254 004141, 180	135 010 205213
097 101 35078	100 254 005180	135 010 20741
097 101 37578	100 254 006213	135 010 20841
097 171 1806	100 254 00720	135 010 20941

Nummernverzeichnis

135 010 491	213	220 301 232	7	350 899 997	11
135 010 732	44	220 320 044	7	351 990 001	82
135 010 776	40	220 320 051	7	351 990 002	13
135 010 805	214	220 320 081	7	380 890 001	138
135 011 004	43	220 320 083	7	470 100 185	203, 207
135 011 110	213	220 329 001	7	470 100 430	197
135 011 132	41	220 330 007	8	470 100 462	197, 203
135 011 133	41	220 330 008	8	470 100 912	205
135 011 134	41	220 330 108	8	470 102 076	197, 203
135 011 429	43	220 339 211	8	470 102 168	197
135 011 507	44	220 339 221	8	470 102 615	197, 203, 207
135 011 508	44	25-0337MG	176	470 102 822	203, 205
135 100 025	214	290 090 198	11	500 011 007	49
135 100 037	42	290 090 294	11	500 011 008	154
135 100 038	42, 151	290 091 828	12	500 011 013	50
135 100 039	42, 151	290 091 835	12	500 011 014	154
135 100 040	42	290 091 850	12	500 011 019	154
135 100 055	42	290 092 850	12	500 011 020	105
135 100 184	214	290 095 926	11	500 011 080	49
135 100 223	187	290 095 927	12	500 011 084	50
135 100 351	42	3 343 231 070	8	500 011 188	50, 105
135 172 220	214	3 343 231 070	9	500 011 204	51
135 172 801	214	3 397 118 505	83	500 011 205	51
135 182 004	100, 150	3 397 118 560	83	500 012 001	104
135 210 402	39	3 397 118 610	83	500 012 004	104
135 210 403	39	300 100 105	14	500 012 005	153
135 210 404	39	300 100 106	14	500 012 006	153
135 210 431	39	300 802 201	138	500 012 007	153
135 211 879	39	343 900 001	15	500 012 008	188
135 250 001	41	343 900 002	15	500 012 009	49
135 250 002	41	343 900 836	15	500 012 010	153
135 250 003	42	345 002 002	78, 134	500 012 011	49
135 251 770	213	345 003 001	78, 134	500 012 015	49
135 252 121	41	345 003 001	209, 210	500 012 016	204, 205
135 254 238	40	350 210 713	140	500 012 241	104
135 255 007	40	350 211 004	139	500 013 003	104
135 255 425	40	350 211 800	139, 179	500 013 004	49
135 255 431	40	350 212 312	84	500 013 079	49
135 255 510	40	350 213 191	140	500 013 180	51
135 255 560	40	350 782 008	168	500 013 181	51
135 280 017	151, 154, 162, 187, 188, 193	350 871 008	10	500 014 001	33, 95
135 280 076	44	350 871 010	10	500 014 002	33, 95
135 280 439	214	350 872 001	10	500 014 003	95
135 460 001	39	350 872 003	10	500 014 004	95
135 460 002	39	350 872 004	138, 179	500 014 005	95, 147, 185
135 460 003	39	350 872 006	10	500 014 006	95, 147, 185
135 620 800	100, 150	350 872 008	138, 179	500 014 007	185
135 630 080	100, 150	350 881 001	177	500 014 008	148, 185
135 751 115	100, 150	350 881 002	80	500 014 039	33
135 751 119	100, 150	350 881 003	137	500 014 042	33
135 751 119	100, 150	350 881 004	211	500 014 106	33
135 751 401	214	350 882 001	11	500 014 107	33
135 801 004	44	350 882 003	11	500 015 001	93
135 801 005	44	350 882 020	211	500 015 002	32, 93
16060-35-009	44, 101	350 882 229	211	500 015 003	32, 93
2 004 652 032	7	350 882 230	211	500 015 006	147
200 290 898	176	350 882 881	202	500 015 007	147
201 210 005	173, 210	350 882 987	11	500 015 011	93
201 250 017	204	350 883 009	8, 80	500 015 101	183, 184
201 252 511	134, 173	350 883 010	137, 178	500 015 324	32
210 200 028	5	350 883 016	178	500 015 337	31
210 200 046	5	350 883 909	9	500 015 707	185
210 211 111	175	350 884 001	9	500 016 002	184
210 211 131	135, 175	350 884 002	137	500 016 003	32
210 211 841	175	350 884 007	9	500 016 003	93, 94
210 212 033	175	350 884 011	10	500 016 203	32, 93, 94
210 212 556	135, 174	350 886 107	211	500 016 501	146
210 213 118	209	350 889 101	9	500 017 003	149
210 213 119	209	350 889 113	8	500 017 007	148
210 213 130	209	350 889 114	8	500 017 013	184
210 213 134	209	350 889 157	211	500 017 014	184
210 310 001	5	350 889 305	9	500 018 001	98
210 320 071	5	350 889 603	137, 178	500 018 002	38
210 320 427	5	350 889 604	137, 178	500 018 080	38
210 322 040	6	350 889 605	137, 178	500 018 180	38
210 323 202	6	350 889 606	137, 178	500 019 001	105
210 323 203	6	350 889 607	137, 178	500 019 002	105
21060-SV-904	102	350 889 998	11	500 020 001	27
220 301 000	7	350 890 054	202	500 020 002	27
220 301 002	7	350 890 781	177	500 020 003	28
220 301 009	7	350 892 704	179	500 020 004	27
220 301 230	7	350 893 032	211	500 020 900	27
220 301 231	7	350 899 988	211	500 020 901	27

Nummernverzeichnis

500 020 902	94	501 100 004	48	520 006 011	55
500 021 009	30	501 190 001	103	520 006 013	34, 99, 148, 185
500 021 010	30	501 190 002	46	520 006 014	34, 55, 99
500 021 011	30	501 190 003	47	520 006 037	112
500 021 012	30	501 190 004	48, 103	520 006 038	55
500 021 013	30	501 190 005	47	520 006 133	111
500 021 014	30	501 190 006	47	520 006 261	111
500 021 015	91	501 190 007	47	520 006 902	56
500 021 018	91	501 190 035	47	520 006 903	55, 56
500 021 019	91	501 190 036	47	520 006 904	37, 55, 56
500 021 019	91	501 200 011	46	520 006 915	37
500 021 020	91	501 200 012	46	520 007 002	114
500 022 001	143	501 200 013	46	520 007 003	156, 189
500 022 306	26, 88	501 290 001	101	520 007 004	156, 189
500 022 409	26, 88	501 300 001	46	520 007 005	156
500 022 411	143	503 019 800	36	520 007 026	114
500 024 706	186	503 019 802	29	520 008 085	113
500 024 732	186	503 019 802	35	520 009 903	37
500 099 001	96, 147	503 019 804	35	520 020 900	94, 146
500 099 002	96	503 019 806	35	520 020 901	94, 146
500 099 003	34	503 019 820	36	520 020 902	146, 184
500 099 024	38	503 019 822	36	521 010 002	66, 123
500 099 025	38	503 019 823	36	521 010 003	123, 165
500 099 046	37	503 019 827	36	521 010 004	66
500 099 428	37	503 019 829	49	521 010 005	123
500 100 122	64	503 019 840	66	521 010 007	165
500 100 125	64	503 019 841	66	521 010 008	123
500 100 133	64	503 019 842	66	521 010 008	165
500 100 134	64	503 019 856	46	521 010 009	196
500 114 001	34, 96, 148, 185	503 019 867	35, 50	521 010 010	66
500 114 003	34, 96	503 186 768	36	521 020 001	124, 216
500 114 004	34, 96	503 190 231	36	521 020 002	124
500 114 005	34, 148	503 191 804	36	521 020 028	196
500 114 006	34, 148	503 191 814	56	521 020 057	124
500 114 029	96	503 191 851	65	521 020 060	123, 216
500 114 472	33	503 191 852	49	521 020 102	124
500 114 603	96	503 191 891	37	522 100 003	65
500 117 002	98	503 192 831	29	522 100 004	65
500 117 003	98	503 198 018	36	522 100 005	65
500 117 004	98	503 919 023	29, 35	522 100 006	121
500 118 002	145, 149	503 928 310	36	522 100 007	122
500 118 003	90, 97	520 001 001	155	522 100 009	115, 157, 190
500 118 004	90, 97	520 001 002	109	522 100 012	120
500 118 030	97	520 001 003	109	522 100 015	165, 195
500 118 701	145, 149	520 001 080	53	522 100 027	62
500 118 703	145, 149	520 001 081	53	522 100 028	62, 63
500 121 001	145 149	520 001 180	53, 109	522 100 030	61
500 121 002	29, 35, 90, 97	520 001 181	54, 109	522 100 031	165
500 121 003	29, 35	520 001 188	53, 109	522 100 032	165
500 121 004	29, 35, 90, 97	520 002 001	54, 108	522 100 033	163, 194
500 121 005	97	520 002 002	54	522 100 034	163, 191
500 121 006	97, 145, 148	520 002 003	54, 108	522 100 035	61
500 121 007	98, 148, 149	520 002 004	108	522 100 037	163, 194
500 121 007	145	520 002 005	109	522 100 038	163, 194
500 121 910	90, 98	520 002 006	155	522 100 039	195
500 121 920	90, 98	520 003 001	109, 155	522 100 050	123
500 121 930	183	520 003 002	54	522 100 053	62
500 121 930	184	520 003 003	54	522 100 061	158
500 122 001	27, 89	520 003 004	155, 188	522 100 068	62
500 122 002	27, 89	520 003 005	156	522 100 069	62
500 122 003	26, 88	520 003 701	155, 188	522 100 070	62
500 122 004	26, 88	520 003 702	156, 188	522 100 102	62
500 122 004	88	520 003 703	156	522 100 107	63
500 122 005	26	520 004 003	54	522 100 113	65
500 122 006	26	520 004 016	112	522 100 118	65
500 122 007	143	520 004 017	112	522 100 124	64
500 122 008	143	520 004 020	56, 111	522 100 140	121
500 122 107	27, 89, 143	520 004 021	111	522 100 146	64
500 122 108	27, 89	520 004 023	161	522 100 163	163
500 123 000	146	520 004 041	110	522 100 258	165, 195
500 200 014	46	520 004 051	55, 112	522 100 281	163
500 211 001	51	520 004 052	56, 112	522 100 602	115
500 211 002	28	520 004 055	113	522 100 603	158, 191
500 211 003	28	520 004 063	189	522 101 021	63
500 211 004	28	520 004 086	110	522 101 024	63
500 218 014	149	520 005 001	155, 186	522 101 058	64
500 218 601	38	520 006 001	204	522 101 059	64
500 221 003	30, 91	520 006 002	56	522 101 076	63
500 221 004	30, 91	520 006 005	111	522 101 172	64
500 221 005	31	520 006 007	112	522 180 004	63
500 221 006	30, 91	520 006 008	112	522 180 007	63
500 221 007	30, 91	520 006 009	113	522 180 204	63
500 321 001	28	520 006 010	113	522 180 207	63

Nummernverzeichnis

522 200 002166
522 200 00367
522 200 004126, 167, 196
522 200 005166
522 200 01067, 125, 166
522 200 01167, 125, 166
522 200 013167
522 200 051124, 166, 196, 216
522 200 064196, 216
522 200 105166, 216
522 200 41866
522 200 41966
522 201 17467
522 230 010126, 216
522 300 001162, 193
522 300 00261
522 300 00361
522 300 00461
522 300 00860
522 300 01361
522 300 02461
522 300 02560
522 300 09460
522 300 10360, 162, 193
522 300 73561, 119
522 300 74161, 119
522 301 31460
522 301 32061
522 301 71460
522 400 001158, 191
522 400 001191
522 400 058157, 190, 191, 196, 216
522 400 060157, 190,
522 400 061190
522 400 063157, 190
522 401 001164
522 401 002164
522 401 003164
522 401 004164
522 401 006195
522 401 007195
522 401 008195
523 019 84444
523 100 00050
523 100 00173
523 100 00276
523 100 00384
523 100 00454
523 100 00459, 73
523 100 005114
523 100 006127
523 100 007127
523 100 00871
523 100 009127
523 100 01071
523 100 01171
523 100 01238
523 100 013127
523 100 01472
523 100 01672
523 100 01772
523 100 01872
523 100 01972
523 100 02074
523 100 02174
523 100 02274
523 100 02375
523 100 02475
523 100 02473
523 100 02575
523 100 026127
523 100 027129
523 100 028129
523 100 02971, 73
523 100 030168
523 100 031168
523 100 033198
523 100 034198
523 100 035169
523 100 037198
523 100 038198
523 100 039169
523 100 040169
523 100 041167
523 100 066130
523 100 067130
523 100 06875
523 100 06975
523 100 07473
523 100 07571
523 100 105204
523 100 109102
523 100 125102
523 100 23472
523 100 246129
523 100 30973
523 101 00745, 101
523 101 02145
523 101 028102
523 101 034102
523 101 08044
523 101 82145
523 120 005130
523 120 006130
523 130 00167
523 130 00467
523 130 00568
523 130 006171
523 130 036171
523 130 047171
523 130 10167
523 130 106171
523 140 501169
523 140 502169
523 140 503199
523 140 504199
523 140 50576
523 140 50676
523 140 508131
523 140 509131
523 140 510131
523 140 511131
523 140 513169
523 140 514169
523 140 515170
523 140 516170
523 140 517170
523 140 518170
523 140 519170
523 140 520170
523 140 521170
523 140 522170
523 140 523170
523 140 524170
523 140 525170
523 140 526170
523 140 527170
523 140 528170
523 140 529170
523 140 530170
523 140 531170
523 140 532170
523 140 533170
523 140 534170
523 140 535170
523 140 536170
523 140 537199
523 140 538199
523 150 00873
523 150 08076
523 150 18876
523 150 19076
523 401 08884
524 100 031160, 192
524 100 032160
524 100 032192
524 100 014159, 192
524 200 709159
524 200 912159
524 200 913159
524 200 914159, 192
524 211 018159
524 212 00258, 116
524 212 00358
524 212 00458, 117
524 212 00559
524 212 006116
524 212 007116
524 213 001117, 160
524 213 002117, 160
524 214 001115
524 214 002162
524 214 00365
524 214 00457
524 214 00558
524 214 00657
524 214 009157, 190
524 214 010157
524 214 010190
524 214 020157, 190
524 214 022157, 190
524 215 001117
524 215 005118
524 215 05758
524 215 501117
524 215 535160, 215
524 216 013161
524 216 055161
524 216 417192
524 216 418192
524 216 754215
524 217 001160
524 217 002160
524 219 00158, 116, 117
524 219 00259, 116
524 219 003116
524 900 01658
524 900 053118, 161
526 006 014148
526 200 00152
526 200 00253
526 200 003107
526 200 004107
526 200 005154
526 200 00652, 107
526 200 00753
526 200 00853
526 200 01152
526 200 01252
526 200 08052
526 200 08452
526 200 18052
526 900 00152
AIS04326
AIS05486
AIS054879
AIS0671135
C13114/4152
C15 300215
C15165/3152
C17225/3152, 187
CF600152
CF700152
CF800152, 187
GE BSX 447
GE BSX127
GEBSX1655
GEBSX1695
GH 760139
H130 50779, 134
H130 511135
H130 519175
H130 790135, 174
H130 820175
HB29 000 10513
HB29 000 10613
HB29 000 10713
HB29 000 10813
HB50 292 03481
HB50 295 03281
HB50 295 03581
HB50 295 03681
HB50 300 12015
HB50 300 21115
HB50 300 61015
HB50 300 81015
IA006278, 134
IA006778, 210
IA0499134, 173

Nummernverzeichnis

IA0914	134, 173
IA1087	174
IA1153	173
IA1198	201
IA1301	201
IA1378	201, 204
IA1379	201
IA1504	206
IS0201	7, 79
IS0254	136
IS0432	6
IS0548	6, 79
IS0670	176
IS0671	135
IS0709	136
IS0711	210
IS0751	80, 136
IS0821	80
IS0836	177, 202
IS0897	177, 202
IS0999	202, 205
IS1109	206
IS1160	177
IS1263	206
IS1393	176
K9	8
LEK 91-12V	81
LK 14732	17, 86
LRS 190	210
LRS 306	210
LRS195	177
ME004317.00	82
ME005167.00	82
ME006038.00	6, 79
ME006817.00	178
ME006818.00	178
N0001	88
N0002	88
N0010	88
N0017	32, 93
N0017-1	146
N0018	32, 93
N0018-1	146
N0019	32, 93
N0020	32, 93
N0021	32, 93
N0040	89, 143
N0041	30, 89, 90, 91, 91, 143, 145
N0041-1	28
N0041-2	28
N0095	99
N0136	31
N0137	29, 31, 90, 92
N0137-1	31, 92
N0138	31, 92
N0138-1	29, 31
N0138-3	145, 146
N0138-4	146
N0138-5	31
N0139	31, 92
N0139-1	146
N0139-2	31, 92
N0139-3	31
N0140	31, 92
N0141	32, 93, 147
N0142	89
N0142-1	144
N0142-9	28
N0142-KT35	183, 184
N0142-KT68	90, 91
N0142-KT75	144, 145
N0142-KT85	29, 30
N0142-KT90	90, 90
N0142-KT95	29, 30
N0149	92
N0149-1	144
N0149-9	28, 29
N0151	88
N0152	88
N0159	95, 147, 184
N0159-1	32, 94
N0165	99
N0166	99
N0209	98
N0235	47, 98
N0241-5	105
N0241-6	105
N0241-7	153
N0241-8	153
N0245	106
N0253	104
N0254	104
N0255	104
N0262	104
N0267	104
N0272	105
N0272-1	50
N0293	106
N0293-2	153
N0293-9	50
N0297	105, 215
N0530	101
N0530-9	46
N0538	101
N0539	101
N0551	102
N0553	101
N0585	135, 176
N0625	82
N0629	82
N0635	107
N0638	107
N0639	107
N0641	108
N0642	108
N0643	108
N0675	103
N0676	103
N1053	188
N1053-1	109
N1164	110
N1181	110
N1187	110
N11910	179
N1195	110
N1200	110
N1210	111, 118
N13140	153
N1389	113
N1405	113
N1406	113
N1415	55, 114, 156
N1415-9	55
N1647	114
N1656	114
N172 000	43
N172 017	43
N1832	115
N1868	115
N1875	115
N1876	115
N1877	116
N188 58 66	12
N1895	117
N190 58 10	12
N1921	117, 161
N1928	118
N1928	161
N2000	118
N2006-10	57
N2006-11	57
N2006-12	57
N2006-13A	57
N2006-13B	57
N2006-9	57
N2008	58, 118, 159, 192
N2011	118
N2075	119
N2075-5	59
N2075-6	162, 193
N2075-7	59
N2075-8	59
N2075-9	59
N2079	119
N2218	120
N2221	122
N2222	122
N2236	120
N2250	120
N2251	120
N2252	120
N2257	121
N2261	122
N2262	121
N2263	121
N2264	120
N2266	121
N2268	121
N2276	122
N2277	122
N2282	122
N2336	124
N2411	126
N2534	124
N2546	125
N2546	167
N2549	125
N2550	125
N2620	125
N2622	125
N2622-1	125, 166
N2654-9	129
N2666-6	13
N2666-7	13
N2666-8	13
N2666-9	14
N2667	82
N2667-9	13
N2668B	82
N2675	14, 82
N2675-8	14, 83, 139
N2675-9	139
N2679	14, 83, 139
N2679-1	139
N2680	14, 83, 139
N2681	15, 83
N2682	80
N2684	9, 80
N2690	84
N2715	87
N2732	85, 128, 180
N2775	81
N2775-1	81
N2776	81
N2782	86
N2784	86
N2786	86
N2788	86
N2789	86, 87
N2793	86
N2794	87
N2795	86
N2796	87
N2799	87
N2801-1	8
N2803-1	80, 87
N28048	161
N2836	126
N2845	126
N2846	126
N2854	126
N2854-9	126
N288	31
N288 58 39	12
N291201	7, 79
N2919-1	85, 128
N2919-2	85, 128
N2920	85, 128
N2920	128, 167
N2953-9	129
N3080010047	88
N3120	81
N3430	13, 82
N380 807	210
N390 396	210
N390112	174, 201
N390122	174, 201
N391102	174
N393 007	209

Nummernverzeichnis

N393 169209
N393 2095
N395 0355
N395 03578
N395 100209
N404 154210
N432 160138, 178
N436 00111
N437 00111
N5041115
N5041415
N5126233205, 206
N600 00781, 137
N601 000138, 179
N601 000179
N601 002137
N602 511138, 179
N603 0099
N603 9109
N702 796187
N705 933215
N707 296214
N71013RE69
N7201269
N72013LI69
N7201469
N7201669
N7201769
N7201869
N722 000167
N722 451198, 215
N722 510167
N722 511167
N729 254198, 215
N845 83212
N9247000359, 119, 162, 193
W940152
WE20 207 103A178
WE29 201 075A178
WE29 201 075A202
WK842/2152
WK962152
ZN 101 0287
ZN 101 2267
ZN 101 3167
ZN 101 3187